

# Y Series

L2000Y Series | L2600Y Series | L3000Y Series

HYUNDAI WIA Multi-Tasking Y-Axis CNC Turning Center

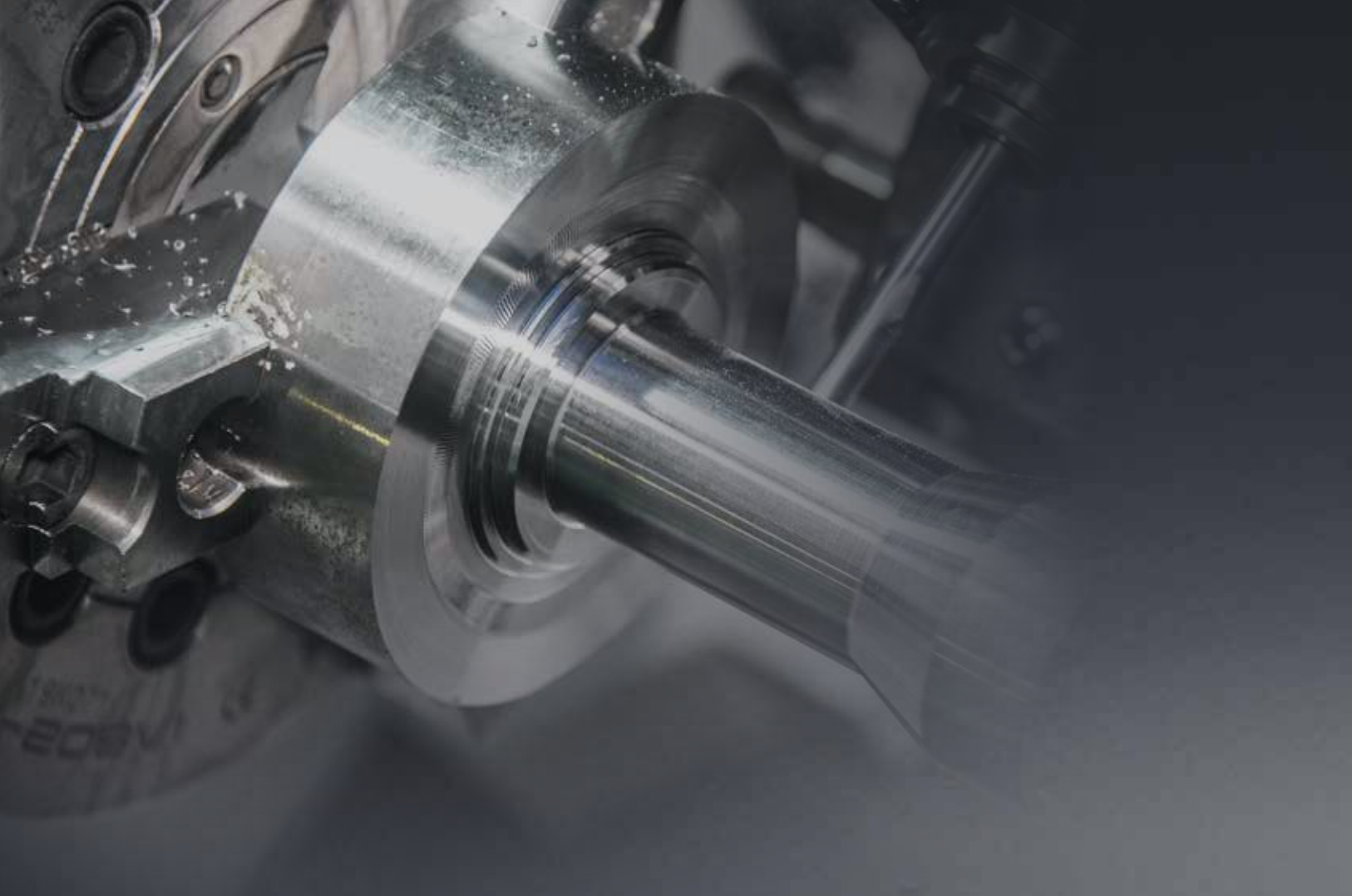

# Technical Leader

The CNC Turning Center L-SY Series, designed with HYUNDAI WIA's engineering expertise to maximize productivity by enhancing rigidity and accuracy of machining.

MODEL	Main Chuck			Sub Chuck		Bed		
	8"	10"	12"	6"	8"	Short	Standard	Long
L2000Y	●					●		
L2000SY	●			●		●		
L2000LY	●						●	
L2000LSY	●			●			●	
L2600Y		●					●	
L2600SY		●		●	○		●	
L2600LY		●						●
L3000Y			●				●	
L3000SY			●	●			●	
L3000LY			●					●

●: Standard ○: Option



# Y Series

Lathe with Y-axis & Box Guideways for Heavy Cutting

- Cycle time reducing structure for maximum productivity
- Multi-tasking operation with wedge type Y-axis BMT65 turret
- Integrated processing through synchronized control of Main/Sub spindle ('S' Type)
- High performance heavy duty cutting enabled with box guideways
- Main/Sub Built-in Spindle application for high precision machining



# 01 BASIC STRUCTURE

Which Can Cover All Machining Process with Only One Initial Setting

## Mill Turret

- BMT65  
5,000 r/min,  $\varnothing 25$  ( $\varnothing 1''$ ) {ER32}

## High Precision Spindle

- Integral body & heat dissipating RIB structure.
- L2000Y Series : 8" / 4,000 r/min
- L2600Y Series : 10" / 3,500 r/min
- L3000Y Series : 12" / 3,500 r/min
- C-Axis Control : 0.001°

## Sub Spindle

- Built-in : 6" [L2600SY 8"]
- Belt : [6"]
- C-Axis Control : 0.001°



## MT#5 Quill Tail Stock

The L-Y series is fitted with tailstocks as a standard for excellent machining quality. In addition, the travel distance of quill can be as long as 120mm(4.7"), thus expanding the support area.

(NC tail stock can be moved separately, providing convenience during workpiece setup. : Option)

# REDUCTION OF NON-CUTTING TIME BY FAST RAPID SPEED

## ALL-IN-ONE TYPE OF BED

### High Precision & Rigidity, One-Piece Structure

Designed with FEM(Finite Element Method) analysis, the L500 Series has bed structure of 30° slope to improve machining accuracy and cutting ability. In addition, increased bed installation area improves vibration absorption and machining stability.



## GUIDEWAY

### Box Guideway

All axes of L-Y Series are designed with Box Guideways for better travel ability. Box Guideways show great performance in offsetting vibrations caused by heavy duty cutting.

### Ball Screw

Large diameter ball screws with preloading prevent deformation due to heat. Also double-anchor support method improves rigidity.

### Rapid Traverse Rate (X/Y/Z)

**30/10/30** m/min (1,181/294/1,181/1,181 ipm)



### Travel (X/Y/Z)

L2000Y/SY

**265/120/590** mm  
(10.4"/4.7"/23.2")

L2000LY/LSY

**265/120/830** mm  
(10.4"/4.7"/32.7")

L2600Y/SY | L3000Y/SY

**265/120/830** mm  
(10.4"/4.7"/32.7")

L2600LY | L3000LY

**265/120/1,350** mm  
(10.4"/4.7"/53.1")



# 02 HIGH PRECISION SPINDLE

Long Lasting, High Accuracy & Excellent Performance CNC Turning Center

[ ] : 선택사항

## Main Spindle Specifications

[ ] : Option

Model	Spindle Speed	Motor (Max./Cont.)	Torque (Max./Cont.)	Chuck Size
L2000Y Series	5,000 rpm (Built-in)	22/11 kW (30/15 HP)	358/301 N·m (264/222 lbft·ft)	8"
	[4,500 rpm (Belt)]	[18.5/11 kW (25/15 HP)]	[314.2/186.2 N·m (231.7/137.3 lbft·ft)]	
L2600Y Series	4,000 rpm (Built-in)	22/15 kW (30/20 HP)	599/409 N·m (441.8/301.7 lbft·ft)	10"
	[3,500 rpm (Belt)]	[26/18.5 kW (35/25 HP)]	[733.7/522.1 N·m (541.1/385.1 lbft·ft)]	
L3000Y Series	3,000 rpm (Built-in)	37/25 kW (50/33.5 HP)	1,262/1,003 N·m (930.8/739.8 lbft·ft)	12"
	[2,800 rpm (Belt)]	[26/18.5 kW (35/25 HP)]	[1,123/664 N·m (828.2/489.7 lbft·ft)]	

## Sub Spindle Specifications

[ ] : Option

Model	Spindle Speed	Motor (Max./Cont.)	Torque (Max./Cont.)	Chuck Size
L-Y Series	6,000 rpm (Built-in)	15/11 kW (20/15 HP)	135/99.1 N·m (99.6/73.1 lbft·ft)	6"
	[4,500 rpm (Belt)]	[11/5.5 kW (15/7.4 HP)]	[124/62.1 N·m (91.5/45.8 lbft·ft)]	
L2600SY	[5,000 rpm (Built-in)]	[22/15 kW (30/20 HP)]	[221/159 N·m (163/117.3 lbft·ft)]	8"

# HEAVY DUTY CUTTING & HIGH ACCURACY

## SPINDLE

### Built-In Main Spindle

Built-in type spindle reduces noise, heat and vibration effectively at high speed rates. Also, rapid acc./deceleration reduces non-cutting time leading to higher productivity.

### C-Axis Control

C-axis of L-Y Series can be controlled to 0.001° which makes it possible to process various shapes.

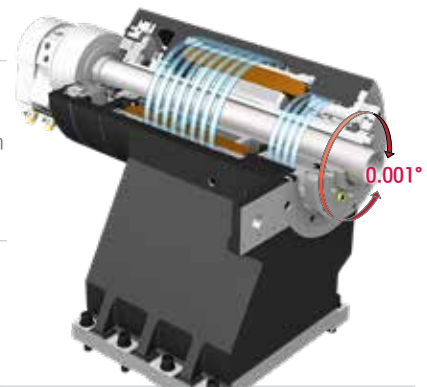

### Built-In Sub Spindle ('S' Type)

The "S" Type built-in sub-spindle has 6" sub-chuck, which enlarges the machining area and improves the workability of the sub spindle with the C-axis control.

When the main spindle cutting is completed, the sub spindle rotation is synchronized with the main spindle allowing the workpiece to be transferred to the sub spindle, and machining can begin on the back side of the workpiece.



## BELT TYPE MAIN SPINDLE

OPTION

Belt type main spindle has a wide torque range and it is designed to minimize thermal displacement. This enables accurate machining during high speed constant processing.

The belt-type sub spindle with 6" chuck is designed to minimize thermal displacement during long duration continuous machining and from heavy-duty cutting to high-speed processing.





# 03 BMT TURRET

High speed, High Accuracy, Highly Reliable Servo Turret

## Mill Turret

[ ] : Option

ITEM	Speed	Motor (Max./Cont)	Torque (Max./Cont)	Collet Size
BMT65	5,000 rpm (FANUC)	5.5/1.5 kW (7.4/2HP)	47.1/33.7 N·m (34.7/24.9 lbf·ft)	Ø25 (1") / ER32
	[5,000 rpm (Power Up)]	[7.5/1.5 kW (10/2HP)]	[95.5/33.7 N·m (70.4/24.9 lbf·ft)]	

### No. of Tools

12<sub>EA</sub>

### Tool Size (O.D/I.D)

□ 25/Ø50<sub>mm</sub> (□ 1"/Ø2")

### Indexing Time

0.15<sub>sec</sub>



# VARIOUS DRIVEN PRECISION BMT TOOL HOLDERS

## TURRET

### BMT65 Turret

The BMT turret secures the tool with four bolts and key on the tool mounting surface of the turret, making it possible to powerfully fix the tool, ensuring high reliability in rigidity and precision.

STRAIGHT MILLING HEAD



ANGULAR MILLING HEAD



### Mill Tool Holder

Machining capability has increased with the addition of straight milling head tool holder, which can machine workpieces from the side, and angular milling head tool holder, which can perform I.D. operations.



## Y-AXIS

### Wedge Type Y-Axis Structure

The HD-SY Series is designed with a wedge type Y-axis that is transferred by the simultaneous operation of the Ys-axis and the X-axis. In addition, excellent rigidity makes it possible to perform superb quality when machining a heavy-duty cutting.

Y-axis Rapid Traverse Rate : 10 m/min

Y-axis Travel : 120 {±60} mm (4.7" {±2.4"})

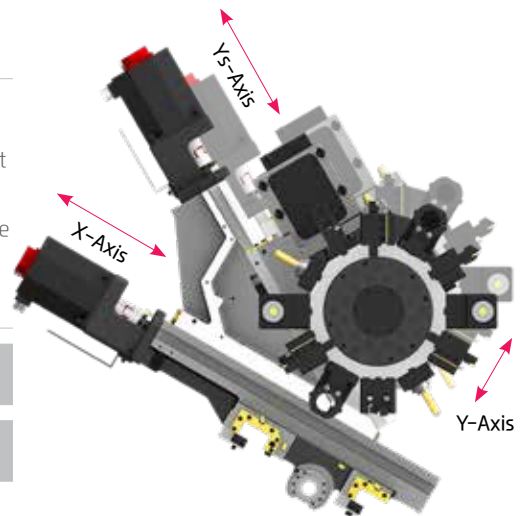

### Special Tool

**OPTION**

With the Y-axis, the L-Y series can process high value-added products using a variety of rotating tools. In particular, there is a multi-holder for attaching a variety of tools to one holder, and an eccentric rotary tool for handling eccentric parts without additional axis travel, which can realize integration of process with one machine.

❖ Consultation needed when ordering these options.

# 04 HYUNDAI WIA FANUC – SMART PLUS

The Compatible All-round Control



**15" Touch-type Monitor as a standard**

	Fast Cycle Time Technology
Smart Machine Control	Fine Surface Technology
	Smart Servo Control Technology
Conversational Program	SmartGuide-i
i-HMI	Machining-aid Function
Part Program Storage	5120M (2MB)
No. of Registerable Programs	1000 EA



# SMART SOFTWARE



## Dialogue Program (Smart Guide-i)

This software offers the maximum user convenience through dialogue manipulation from setup to processing. This includes writing processing programs and simulation checks.

## Convenience Function S/W

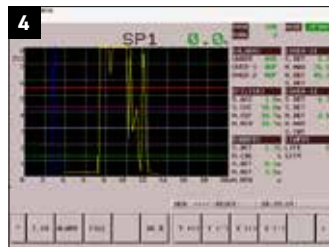

1. Thermal Displacement Compensation (HW-TDC) **OPTION**  
This software improves processing precision by minimizing thermal deformation from changes in external environments and machining.

2. Machine Guidance (HW-MCG)  
This software offers various user convenience functions such as tool manipulation, maintenance, tool monitoring, and a pop-up/status

3. LAUNCHER  
This software offers shortcuts for quick access to specialized features and frequently used features.

4. Tool Monitoring (HW-TM) **OPTION**  
This tool status monitoring software monitors and protects workpiece, tools, and equipment through real-time monitoring of the motor load from machining.

## Machining Support S/W

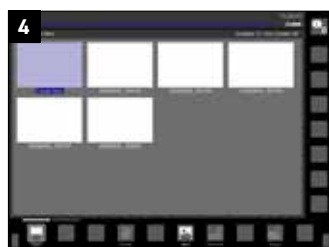

1. Premium Tool Operation  
This software offers premium graphic functions for more intuitive tool operation.

2. Manual Viewer  
This software enables users to view electronic manuals right from the tool.

3. Scheduling  
This software enables viewing/setting up directly from the tool. This allows such actions as managing customer's tool schedules and schedule notification.

4. Operation Memo  
This software is capable of managing customer notes such as tool information and issues.

# SPECIFICATIONS

## Standard & Optional

Spindle		L2000Y/LY	L2000SY/LSY
Main Spindle Hollow Chuck 3 Jaw	8"	●	●
Main Spindle Solid Chuck 3 Jaw	8"	☆	☆
Sub Spindle Hollow Chuck 3 Jaw	6"	-	●
Sub Spindle Solid Chuck 3 Jaw	6"	-	☆
Standard Soft Jaw (1set)		●	●
Chuck Clamp Foot Switch		●	●
2 Steps Hyd. Pressure Device		○	○
Spindle Inside Stopper		☆	☆
5" Index		☆	☆
Cs-Axis (0.001")		●	●
2 Steps Chuck Foot Switch		○	○
Chuck Open/Close Confirmation Device		○(CE:●)	○(CE:●)
Sub Spindle Foot Switch		-	●
<b>Turret</b>			
Tool Holder		●	●
Mill Turret	BMT	●	●
Straight Milling Head (Radial)	Collet Type,2ea	●	●
Angular Milling Head (Axial)	Collet Type,2ea	●	●
Straight Milling Head (Radial)	Adapter Type	○	○
Angular Milling Head (Axial)	Adapter Type	○	○
Boring Sleeve		●	●
Drill Socket		●	●
U-Drill Holder		○	○
U-Drill Holder Sleeve		○	○
O.D Extension Holder	For Out-Dia	☆	☆
Angle Head		☆	☆
<b>Tail Stock &amp; Steady Rest</b>			
Programmable + Quill Tail Stock(MT#5)		●	-
Programmable + Built-in Tail Stock(MT#4)		○	-
NC Feed + Quill Tail Stock(MT#5)		○	-
NC Feed + Built-in Tail Stock(MT#4)		○	-
Manual Hyd. Steady Rest		☆	☆
Programmable Hyd. Steady Rest		○/☆	○/☆
Standard Live Center		●	-
High Precision Live Center		○	-
2 Steps Tail Stock Pressure System		☆	-
Tail Stock Foot Switch (When Tail Stock is selected)		●	-
Quill Forward/Reverse Confirmation Device		○	-
<b>Coolant &amp; Air Blow</b>			
Standard Coolant (Nozzle)		●	●
Chuck Coolant (Upper Chuck)		○	○
Gun Coolant		○	○
Through Spindle Coolant (Only for Special Chuck)		☆	☆
Turnmill Through Coolant		-	-
Chuck Air Blow (Upper Chuck)		○	○
Sub Spindle Air Blow		-	-
Tail Stock Air Blow (Upper Tail Stock)		☆	-
Turret Air Blow		☆	☆
Air Gun		○	○
Through Spindle Air Blow (Only for Special Chuck)		☆	☆
High Pressure Coolant	6Bar (87psi)	●	●
	20Bar (290psi)	○	○
	70Bar (1,015psi)	○	○
Power Coolant System (For Automation)		☆	☆
Coolant Chiller (When selecting Sub Tank Type, Chip Conveyor)		☆	☆
<b>Chip Disposal</b>			
Coolant Tank	275 ℓ (72.6 gal)	●/-	●/-
	290 ℓ (76.6 gal)	-/●	-/●
Chip Conveyor (Hinge/Scraper)	Front (Right)	○	○
	Rear (Rear)	-/○	-/○
Special Chip Conveyor (Drum Filter)		☆	☆
Chip Wagon	Standard (180 ℓ)	○	○
	Swing(200 ℓ)	○	○
	Large Swing (290 ℓ)	○	○
	Large Size (330 ℓ)	○	○
	Customized	☆	☆
<b>Safety Device</b>			
Total Splash Guard		●	●
Chuck hydraulic pressure maintenance interlock		○(CE:●)	○(CE:●)

● : Standard ○ : Option ☆ : Prior Consultation - : Non Applicable

Electric Device		L2000Y/LY	L2000SY/LSY
Call Light	1Color : ●	●	●
Call Light & Buzzer	3Color : ● ● ● B	○	○
Electric Cabinet Light		○	○
Remote MPG		-	-
Work Counter	Digital	○	○
Total Counter	Digital	○	○
Tool Counter	Digital	○	○
Multi Tool Counter	Digital	○	○
Electric Circuit Breaker		○	○
AVR (Auto Voltage Regulator)		☆	☆
Transformer	40kVA	○	-
	40kVA (Belt)	-	○
	60kVA (Built-in)	-	○
Auto Power Off		○	○
<b>Measurement</b>			
Manual Q-Setter		-	-
Automatic Q-Setter		●	●
Work Close Confirmation Device	TACO	○	○
(Only for Special Chuck)	SMC	○	○
Work Setter		☆	☆
Linear Scale	X axis	☆	☆
	Z axis	☆	☆
Coolant Level Sensor (Only for Chip Conveyor)		☆	☆
<b>Environment</b>			
Air Conditioner		○	○
Oil Mist Collector		☆	☆
Oil Skimmer (Only for Chip Conveyor)		○	○
MQL (Minimal Quantity Lubrication)		☆	☆
<b>Fixture &amp; Automation</b>			
Auto Door	High Speed	○	○
Auto Shutter (Only for Automatic System)		☆	☆
Sub Operation Panel		☆	☆
Bar Feeder Interface		○	○
Bar Feeder (FEDEK)		☆	☆
Sub Sp. Work Eject (Pneumatic Type)		-	○
Sub Sp. Work Pusher (Spring Type)		-	○
Turret Work Pusher (For Automation)		☆	☆
Extra M-Code 4ea		○	○
Automation Interface		☆	☆
I/O Extension (IN & OUT)	16 Contact	○	○
	32 Contact	○	○
Parts Catcher	Main SP.	○	○
	Sub SP.	-	○
Parts Conveyor(Feed to Main Part Catcher)		☆	☆
Front Loading Semi Automation		☆	☆
<b>Hyd. Device</b>			
Standard Hyd. Cylinder	Hollow	●	●
Standard Hyd. Unit	35bar(507.6psi) / 14 ℓ	●	●
<b>S/W</b>			
DNC software (HW-eDNC)		○	○
Machine Monitoring System (HW-MMS Cloud/Edge/Remote)		○	○
Machine Monitoring System & Analysis (HW-MMS Edge Plus)		☆	☆
Conversational program (HW-DPRO)		○	○
SmartGuide-i : FANUC		●	●
Thermal Displacement Compensation (HW-TDC)		○	○
Tool Monitoring (HW-TM) : FANUC		○	○
Machine Guidance (HW-MCG) : FANUC		●	●
Energy Saving System (HW-ESS) : FANUC		●	●
Premium Tool Operation : FANUC		●	●
Manual Viewer : FANUC		●	●
Scheduling : FANUC		●	●
Operation Memo : FANUC		●	●
<b>ETC</b>			
Tool Box		●	●
Customized Color	Need Munsell No.	☆	☆
CAD & CAM		☆	☆

❖ 4 channel of TDC(Thermal Displacement Compensation) device is recommended, when more than 6 bar of high pressure coolant is applied, for the high quality machining.  
Specifications are subject to change without notice for improvement.



# SPECIFICATIONS

## Standard & Optional

Spindle		L2600Y/LY	L2600SY
Main Spindle Hollow Chuck 3 Jaw	10"	●	●
Main Spindle Solid Chuck 3 Jaw	10"	☆	☆
Sub Spindle Hollow Chuck 3 Jaw	6" 8"	- -	● ○
Sub Spindle Solid Chuck 3 Jaw	6" 8"	- -	☆ -
Standard Soft Jaw (1set)		●	●
Chuck Clamp Foot Switch		●	●
2 Steps Hyd. Pressure Device		○	○
Spindle Inside Stopper		☆	☆
5° Index		☆	☆
Cs-Axis (0.001°)		●	●
2 Steps Chuck Foot Switch		○	○
Chuck Open/Close Confirmation Device		○(CE:●)	○(CE:●)
Sub Spindle Foot Switch		-	●
<b>Turret</b>			
Tool Holder		●	●
Mill Turret	BMT	●	●
Straight Milling Head (Radial)	Collet Type,2ea	●	●
Angular Milling Head (Axial)	Collet Type,2ea	●	●
Straight Milling Head (Radial)	Adapter Type	○	○
Angular Milling Head (Axial)	Adapter Type	○	○
Boring Sleeve		●	●
Drill Socket		●	●
U-Drill Holder		○	○
U-Drill Holder Sleeve		○	○
O.D Extension Holder	For Out-Dia	☆	☆
Angle Head		☆	☆
<b>Tail Stock &amp; Steady Rest</b>			
Programmable + Quill Tail Stock(MT#5)		●	-
Programmable + Built-in Tail Stock(MT#4)		○	-
NC Feed + Quill Tail Stock(MT#5)		○	-
NC Feed + Built-in Tail Stock(MT#4)		○	-
Manual Hyd. Steady Rest		☆	☆
Programmable Hyd. Steady Rest		○/☆	☆
Standard Live Center		●	-
High Precision Live Center		○	-
2 Steps Tail Stock Pressure System		☆	-
Tail Stock Foot Switch (When Tail Stock is selected)		●	-
Quill Forward/Reverse Confirmation Device		○	-
<b>Coolant &amp; Air Blow</b>			
Standard Coolant (Nozzle)		●	●
Chuck Coolant (Upper Chuck)		○	○
Gun Coolant		○	○
Through Spindle Coolant (Only for Special Chuck)		☆	☆
Turmill Through Coolant		-	-
Chuck Air Blow (Upper Chuck)		○	○
Sub Spindle Air Blow		-	○
Tail Stock Air Blow (Upper Tail Stock)		☆	-
Turret Air Blow		☆	☆
Air Gun		○	○
Through Spindle Air Blow (Only for Special Chuck)		☆	☆
High Pressure Coolant	6Bar (87psi)	●	●
	20Bar (290psi)	○	○
	70Bar (1,015psi)	○	○
Power Coolant System (For Automation)		☆	☆
Coolant Chiller (When selecting Sub Tank Type, Chip Conveyor)		☆	☆
<b>Chip Disposal</b>			
Coolant Tank	290ℓ (76.6 gal)	●/-	●
	320ℓ (84.5 gal)	-/●	-
Chip Conveyor (Hinge/Scraper)	Front (Right)	○	○
	Rear (Rear)	○	○
Special Chip Conveyor (Drum Filter)		☆	☆
Chip Wagon	Standard (180ℓ)	○	○
	Swing(200ℓ)	○	○
	Large Swing (290ℓ)	○	○
	Large Size (330ℓ)	○	○
	Customized	☆	☆
<b>Safety Device</b>			
Total Splash Guard		●	●
Chuck hydraulic pressure maintenance interlock		○(CE:●)	○(CE:●)

● : Standard ○ : Option ☆ : Prior Consultation - : Non Applicable

Electric Device		L2600Y/LY	L2600SY
Call Light	1Color : ●	●	●
Call Light & Buzzer	3Color : ●●● B	○	○
Electric Cabinet Light		○	○
Remote MPG		-	-
Work Counter	Digital	○	○
Total Counter	Digital	○	○
Tool Counter	Digital	○	○
Multi Tool Counter	Digital	○	○
Electric Circuit Breaker		○	○
AVR (Auto Voltage Regulator)		☆	☆
Transformer	40KVA	○	-
	45kVA (Belt)	-	○
	60KVA (Built-in)	-	○
Auto Power Off		○	○
<b>Measurement</b>			
Manual Q-Setter		-	-
Automatic Q-Setter		●	●
Work Close Confirmation Device	TACO	○	○
(Only for Special Chuck)	SMC	○	○
Work Setter		☆	☆
Linear Scale	X axis	☆	☆
	Z axis	☆	☆
Coolant Level Sensor (Only for Chip Conveyor)		☆	☆
<b>Environment</b>			
Air Conditioner		○	○
Oil Mist Collector		☆	☆
Oil Skimmer (Only for Chip Conveyor)		○	○
MQL (Minimal Quantity Lubrication)		☆	☆
<b>Fixture &amp; Automation</b>			
Auto Door	High Speed	○	○
Auto Shutter (Only for Automatic System)		☆	☆
Sub Operation Panel		☆	☆
Bar Feeder Interface		○	○
Bar Feeder (FEDEK)		☆	☆
Sub Sp. Work Eject (Pneumatic Type)		-	○
Sub Sp. Work Pusher (Spring Type)		-	○
Turret Work Pusher (For Automation)		☆	☆
Extra M-Code 4ea		○	○
Automation Interface		☆	☆
I/O Extension (IN & OUT)	16 Contact	○	○
	32 Contact	○	○
Parts Catcher	Main SP.	○	○
	Sub SP.	-	○
Parts Conveyor(Feed to Main Part Catcher)		☆	☆
Front Loading Semi Automation		☆	☆
<b>Hyd. Device</b>			
Standard Hyd. Cylinder	Hollow	●	●
Standard Hyd. Unit	35bar(507.6psi) / 14ℓ	●	●
<b>S/W</b>			
DNC software (HW-eDNC)		○	○
Machine Monitoring System (HW-MMS Cloud/Edge/Remote)		○	○
Machine Monitoring System & Analysis (HW-MMS Edge Plus)		☆	☆
Conversational program (HW-DPRO)		○	○
SmartGuide-i : FANUC		●	●
Thermal Displacement Compensation (HW-TDC)		○	○
Tool Monitoring (HW-TM) : FANUC		○	○
Machine Guidance (HW-MCG) : FANUC		●	●
Energy Saving System (HW-ESS) : FANUC		●	●
Premium Tool Operation : FANUC		●	●
Manual Viewer : FANUC		●	●
Scheduling : FANUC		●	●
Operation Memo : FANUC		●	●
<b>ETC</b>			
Tool Box		●	●
Customized Color	Need Munsel No.	☆	☆
CAD & CAM		☆	☆

❖ 4 channel of TDC(Thermal Displacement Compensation) device is recommended, when more than 6 bar of high pressure coolant is applied, for the high quality machining.  
Specifications are subject to change without notice for improvement.

# SPECIFICATIONS

## Standard & Optional

Spindle		L3000Y/LY	L3000SY
Main Spindle Hollow Chuck 3 Jaw	12"	●	●
Main Spindle Solid Chuck 3 Jaw	12"	☆	☆
Sub Spindle Hollow Chuck 3 Jaw	6"	-	●
Sub Spindle Solid Chuck 3 Jaw	6"	-	☆
Standard Soft Jaw (1set)		●	●
Chuck Clamp Foot Switch		●	●
2 Steps Hyd. Pressure Device		○	○
Spindle Inside Stopper		☆	☆
5" Index		☆	☆
Cs-Axis (0.001")		●	●
2 Steps Chuck Foot Switch		○	○
Chuck Open/Close Confirmation Device		○(CE:●)	○(CE:●)
Sub Spindle Foot Switch		-	●
<b>Turret</b>			
Tool Holder		●	●
Mill Turret	BMT	●	●
Straight Milling Head (Radial)	Collet Type,2ea	●	●
Angular Milling Head (Axial)	Collet Type,2ea	●	●
Straight Milling Head (Radial)	Adapter Type	○	○
Angular Milling Head (Axial)	Adapter Type	○	○
Boring Sleeve		●	●
Drill Socket		●	●
U-Drill Holder		○	○
U-Drill Holder Sleeve		○	○
O.D Extension Holder	For Out-Dia	☆	☆
Angle Head		☆	☆
<b>Tail Stock &amp; Steady Rest</b>			
Programmable + Quill Tail Stock(MT#5)		●	-
Programmable + Built-in Tail Stock(MT#4)		○	-
NC Feed + Quill Tail Stock(MT#5)		○	-
NC Feed + Built-in Tail Stock(MT#4)		○	-
Manual Hyd. Steady Rest		☆	☆
Programmable Hyd. Steady Rest		○/☆	☆
Standard Live Center		●	-
High Precision Live Center		○	-
2 Steps Tail Stock Pressure System		☆	-
Tail Stock Foot Switch (When Tail Stock is selected)		●	-
Quill Forward/Reverse Confirmation Device		○	-
<b>Coolant &amp; Air Blow</b>			
Standard Coolant (Nozzle)		●	●
Chuck Coolant (Upper Chuck)		○	○
Gun Coolant		○	○
Through Spindle Coolant (Only for Special Chuck)		☆	☆
Turnmill Through Coolant		-	-
Chuck Air Blow (Upper Chuck)		○	○
Sub Spindle Air Blow		-	○
Tail Stock Air Blow (Upper Tail Stock)		☆	-
Turret Air Blow		☆	☆
Air Gun		○	○
Through Spindle Air Blow (Only for Special Chuck)		☆	☆
High Pressure Coolant	6Bar (87psi)	●	●
	20Bar (290psi)	○	○
	70Bar (1,015psi)	○	○
Power Coolant System (For Automation)		☆	☆
Coolant Chiller (When selecting Sub Tank Type, Chip Conveyor)		☆	☆
<b>칩처리</b>			
Coolant Tank	290 ℓ (76.6 gal)	●/-	●
	320 ℓ (84.5 gal)	-/●	-
Chip Conveyor (Hinge/Scraper)	Front (Right)	○	○
	Rear (Rear)	○	○
Special Chip Conveyor (Drum Filter)		☆	☆
Chip Wagon	Standard (180 ℓ)	○	○
	Swing(200 ℓ)	○	○
	Large Swing (290 ℓ)	○	○
	Large Size (330 ℓ)	○	○
	Customized	☆	☆
<b>Safety Device</b>			
Total Splash Guard		●	●
Chuck hydraulic pressure maintenance interlock		○(CE:●)	○(CE:●)

● : Standard ○ : Option ☆ : Prior Consultation - : Non Applicable

Electric Device		L3000Y/LY	L3000SY
Call Light	1Color : ●	●	●
Call Light & Buzzer	3Color : ● ● ● B	○	○
Electric Cabinet Light		○	○
Remote MPG		-	-
Work Counter	Digital	○	○
Total Counter	Digital	○	○
Tool Counter	Digital	○	○
Multi Tool Counter	Digital	○	○
Electric Circuit Breaker		○	○
AVR (Auto Voltage Regulator)		☆	☆
Transformer	40kVA (Belt)	○	-
	50kVA (Built-in)	○	-
	45kVA (Belt)	-	○
	65kVA (Built-in)	-	○
Auto Power Off		○	○
<b>Measurement</b>			
Manual Q-Setter		-	-
Automatic Q-Setter		●	●
Work Close Confirmation Device	TACO	○	○
(Only for Special Chuck)	SMC	○	○
Work Setter		☆	☆
Linear Scale	X axis	☆	☆
	Z axis	☆	☆
Coolant Level Sensor (Only for Chip Conveyor)		☆	☆
<b>Environment</b>			
Air Conditioner		○	○
Oil Mist Collector		☆	☆
Oil Skimmer (Only for Chip Conveyor)		○	○
MQL (Minimal Quantity Lubrication)		☆	☆
<b>Fixture &amp; Automation</b>			
Auto Door	High Speed	○	○
Auto Shutter (Only for Automatic System)		☆	☆
Sub Operation Panel		○	☆
Bar Feeder Interface		○	○
Bar Feeder (FEDEK)		☆	☆
Sub Sp. Work Eject (Pneumatic Type)		-	○
Sub Sp. Work Pusher (Spring Type)		-	○
Turret Work Pusher (For Automation)		☆	☆
Extra M-Code 4ea		○	○
Automation Interface		☆	☆
I/O Extension (IN & OUT)	16 Contact	○	○
	32 Contact	○	○
Parts Catcher	Main SP.	○	○
	Sub SP.	-	○
Parts Conveyor(Feed to Main Part Catcher)		☆	☆
Front Loading Semi Automation		☆	☆
<b>Hyd. Device</b>			
Standard Hyd. Cylinder	Hollow	●	●
Standard Hyd. Unit	35bar(507.6psi) / 14 ℓ	●	●
<b>S/W</b>			
DNC software (HW-eDNC)		○	○
Machine Monitoring System (HW-MMS Cloud/Edge/Remote)		○	○
Machine Monitoring System & Analysis (HW-MMS Edge Plus)		☆	☆
Conversational program (HW-DPRO)		○	○
SmartGuide-i : FANUC		●	●
Thermal Displacement Compensation (HW-TDC)		○	○
Tool Monitoring (HW-TM) : FANUC		○	○
Machine Guidance (HW-MCG) : FANUC		●	●
Energy Saving System (HW-ESS) : FANUC		●	●
Premium Tool Operation : FANUC		●	●
Manual Viewer : FANUC		●	●
Scheduling : FANUC		●	●
Operation Memo : FANUC		●	●
<b>ETC</b>			
Tool Box		●	●
Customized Color	Need Munsell No.	☆	☆
CAD & CAM		☆	☆

❖ 4 channel of TDC(Thermal Displacement Compensation) device is recommended, when more than 6 bar of high pressure coolant is applied, for the high quality machining.  
Specifications are subject to change without notice for improvement.

# SPECIFICATIONS

## Spindle Output/Torque Diagram

### L2000Y 5,000 rpm

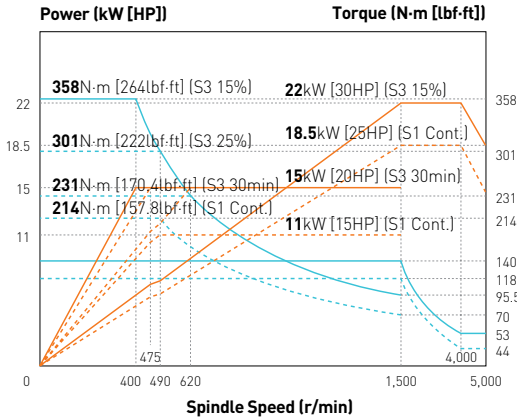

### L2600Y 4,000 rpm

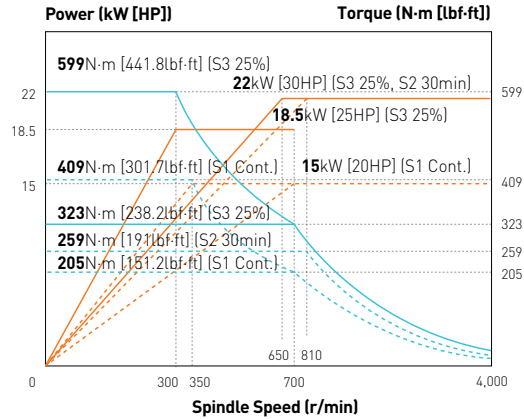

### L3000Y 3,000 rpm

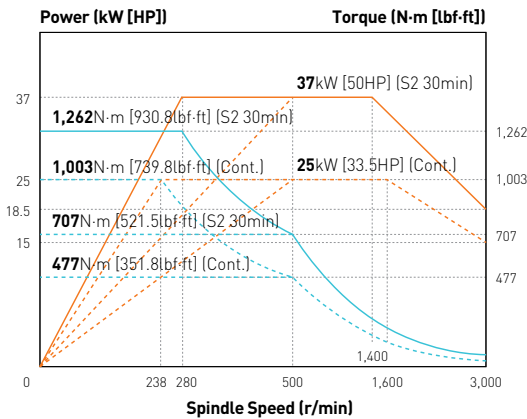

### Sub Sp. 6,000 rpm

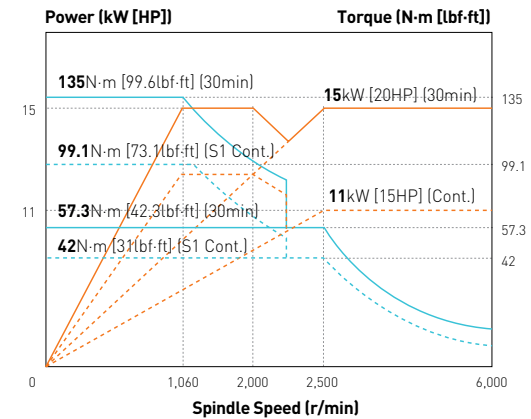

### L2600SY 8" Sub Sp. 5,000 rpm

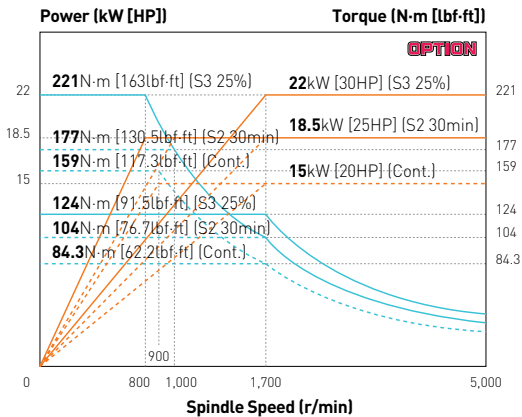

### Turn/Mill 5,000 rpm

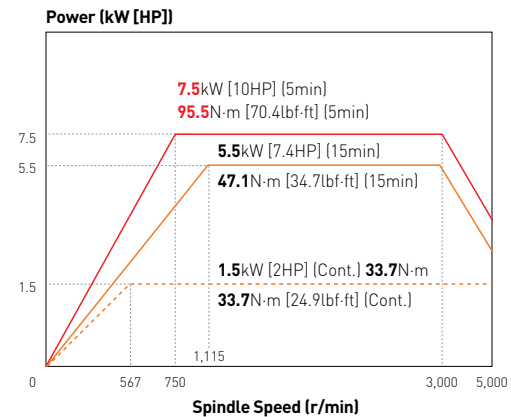

# SPECIFICATIONS

## Spindle Output/Torque Diagram

### L2000Y 4,500 rpm

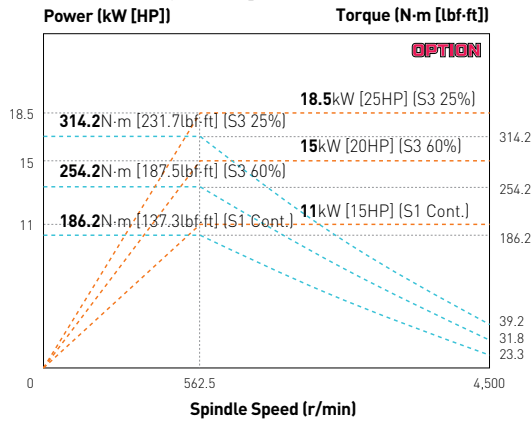

### L2600Y 3,500 rpm

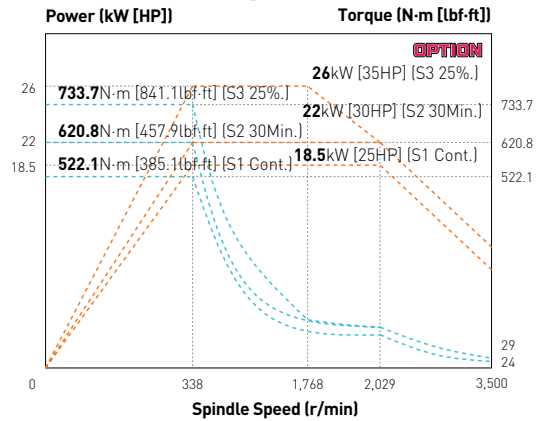

### L3000Y 2,800 rpm

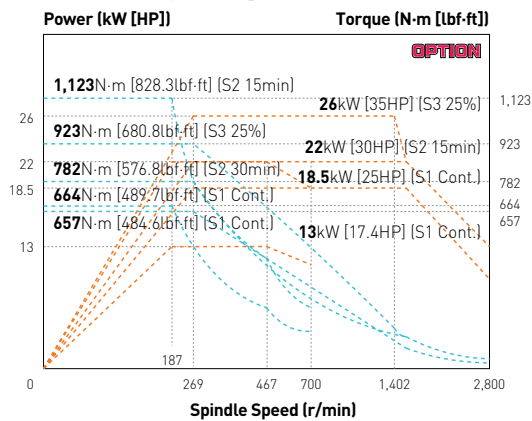

### Sub Sp. 4,500 rpm

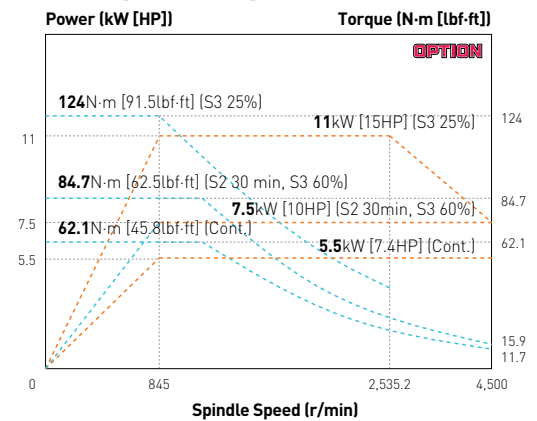



# SPECIFICATIONS

## External Dimensions

unit : mm(in)

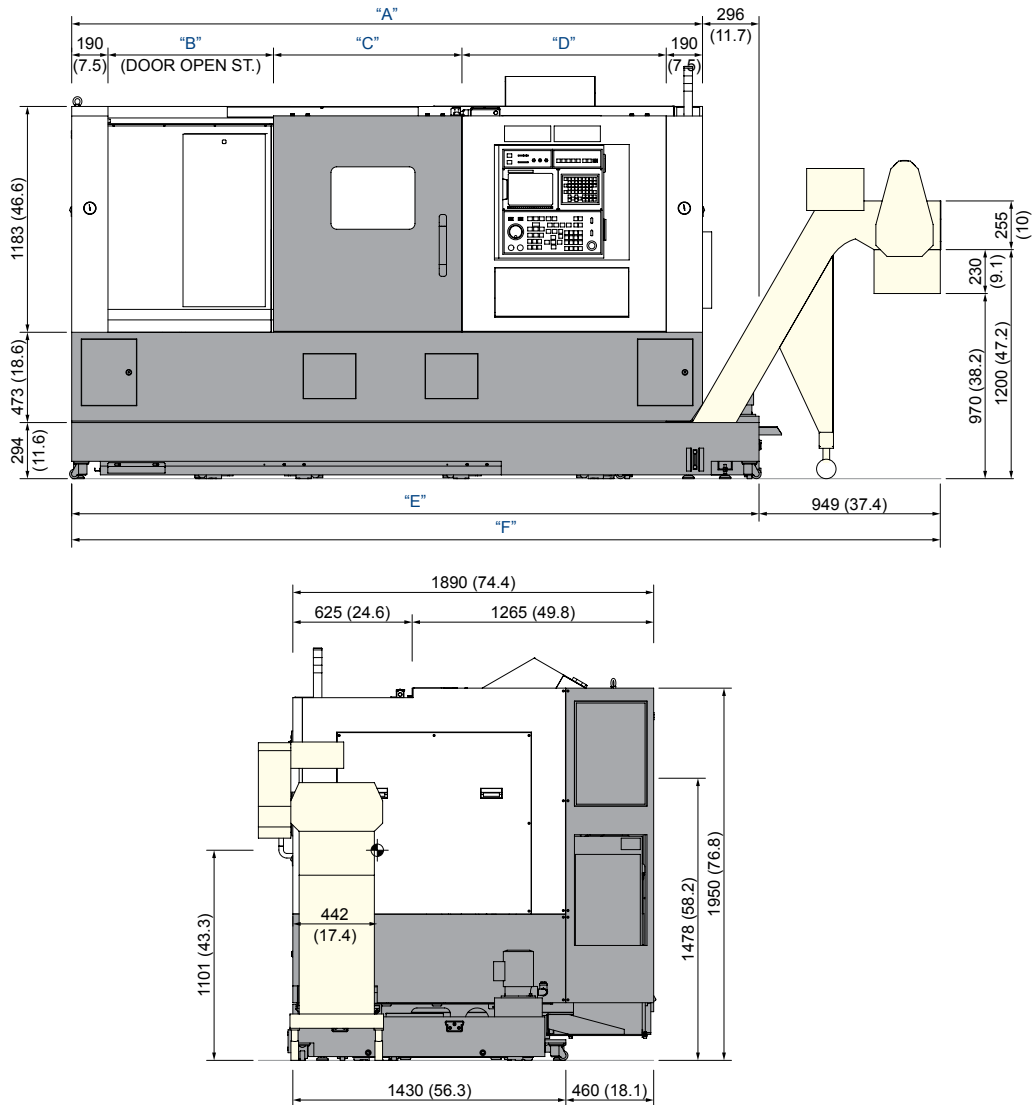

ITEM	L2000SY/L2000Y	L2000LSY / L2000LY / L2600SY L2600Y / L3000SY / L3000Y	L2600LY / L3000LY (2 DOOR TYPE)
"A"	2,974 (117.1")	3,304 (130.1")	4,074 (160.4")
"B"	690 (27.2")	860 (33.9")	841 (33.1")-Left / 651 (25.6")-Right
"C"	847 (33.3")	987 (38.9")	987 (38.9")
"D"	1,030 (40.6")	1,070 (42.1")	663 (26.1")
"E"	3,280 (129.1")	3,600 (141.7")	4,315 (169.9")
"F"	4,229 (166.5")	4,549 (179.1")	5,315 (209.3")

# SPECIFICATIONS

Interference

unit : mm(in)

Y Series

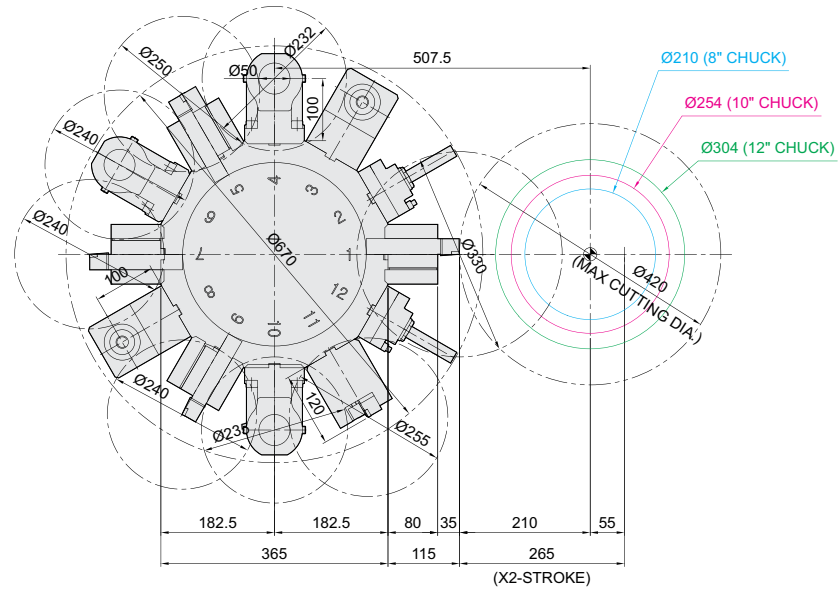

SY Series

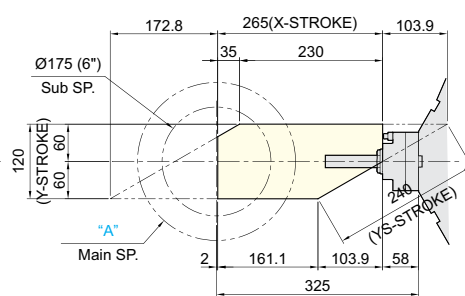
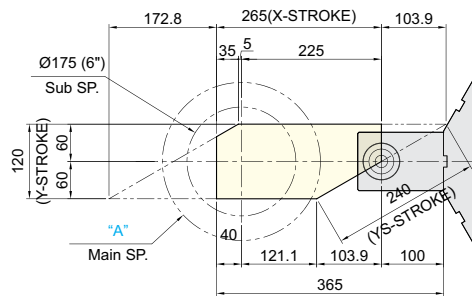
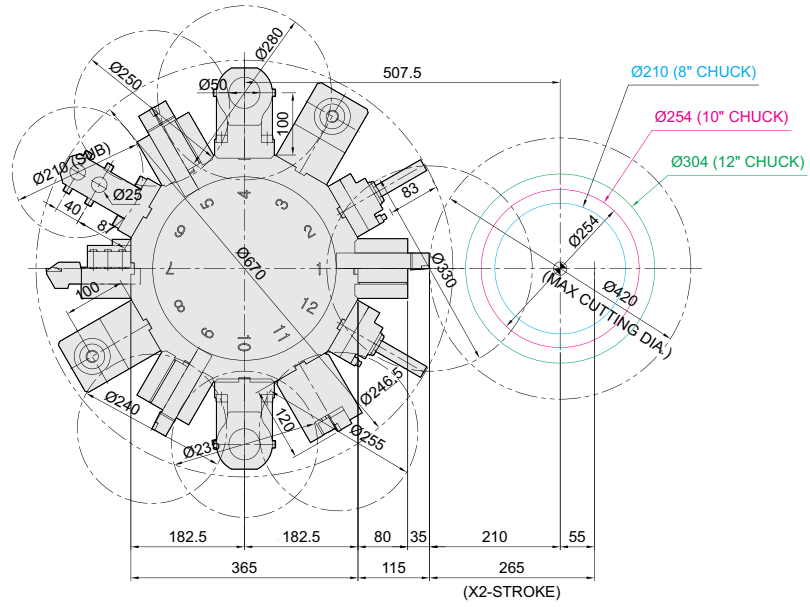

"A" : L2000 Series (8") | L2600 Series (10") | L3000 Series (12")

# SPECIFICATIONS

## Tooling System

unit : mm(in)

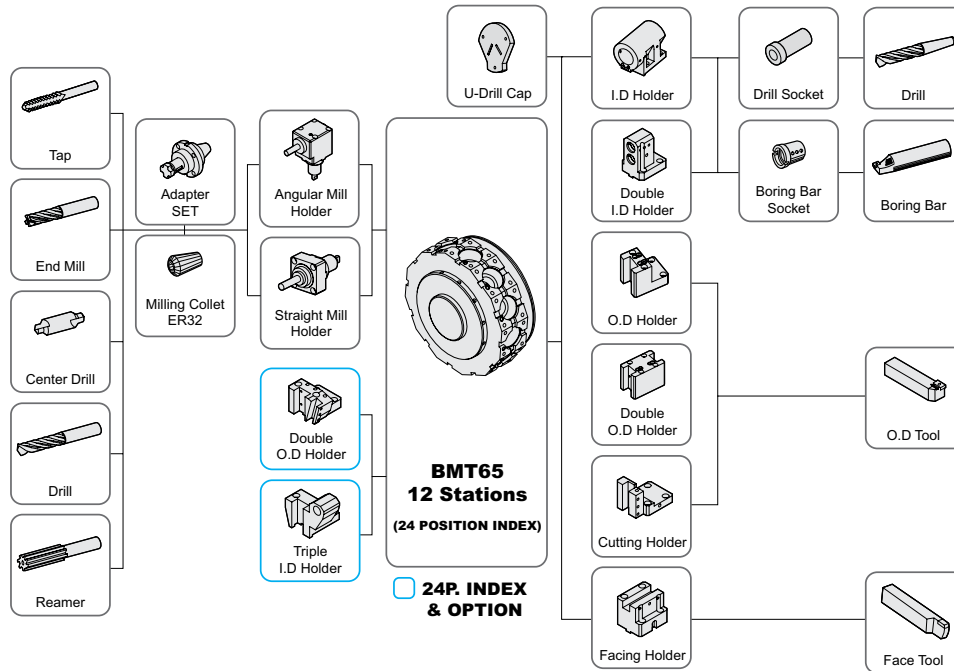

## Tooling Parts Detail

ITEM			Y Type (12P)		SY Type (12P)		SY Type (24P : Opt.)	
			mm Unit	inch Unit	mm Unit	inch Unit	mm Unit	inch Unit
Turning Holder	O.D Holder	Right/Left	4	4	2	2	1	1
		Double	-	-	1	1	1	1
		Double (24P. Rear)	-	-	-	-	1	1
		Double (24P)	-	-	-	-	1	1
	Facing Holder		1	1	1	1	1	1
	Cutting Holder		-	-	1	1	1	1
Boring Holder	I.D Holder	Single	3	3	2	2	1	1
		Double	-	-	1	1	-	-
		Triple	-	-	-	-	1	1
	U-Drill Holder	Cap	1	1	1	1	1	1
Driven Holder	Straight Mill Holder	Standard	2	2	2	2	2	2
	Angular Mill Holder	Standard	2	2	2	2	2	2
Socket	Boring	Ø16 (Ø5/8")	1	-	1	-	1	-
		Ø20 (Ø3/4")	1	1	1	1	1	1
		Ø25 (Ø1")	1	1	1	1	1	1
		Ø32 (Ø1 1/4")	1	1	1	1	1	1
		Ø40 (Ø1 1/2")	1	1	1	1	1	1
		Ø45 (Ø1 3/4")	-	1	-	1	-	1
	Sub Boring	Ø10 (Ø3/8")	-	-	1	1	1	1
		Ø12 (Ø1/2")	-	-	1	1	1	1
		Ø16 (Ø5/8")	-	-	1	1	1	1
		Ø20 (Ø3/4")	-	-	1	1	1	1
	Drill	MT 2	1	1	1	1	1	1
		MT 3	1	1	1	1	1	1
		MT 4	1	1	1	1	1	1
		ER Collet	1 Set	1 Set	1 Set	1 Set	1 Set	1 Set
		Adapter Set	1 Set	1 Set	1 Set	1 Set	1 Set	1 Set

Specifications are subject to change without notice for improvement.

# SPECIFICATIONS

## Tooling Travel Range

unit : mm(in)

L2000Y

**O.D. Tool holder**

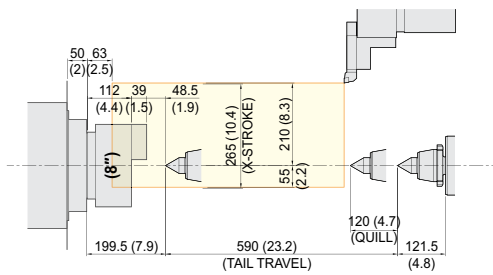

**I.D. Tool holder**

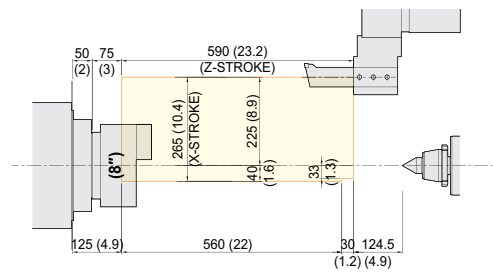

**Axial driven Tool holder**

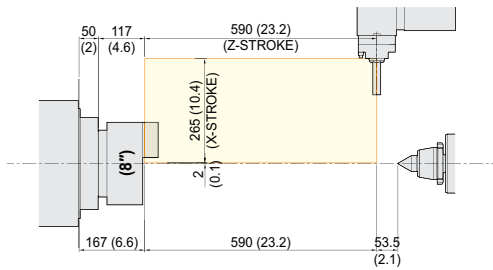

**Angular driven Tool holder**

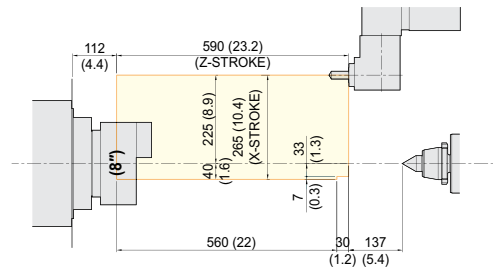

**Face Tool holder**

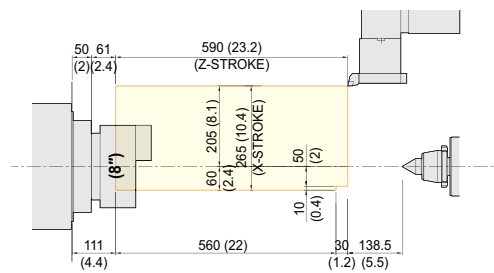



# SPECIFICATIONS

## Tooling Travel Range

unit : mm(in)

### L2000LY

#### O.D. Tool holder

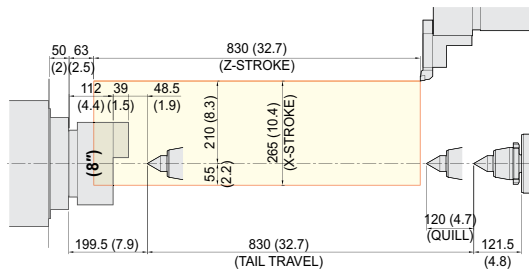

#### I.D. Tool holder

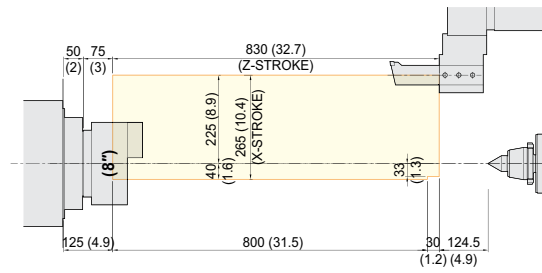

#### Axial driven Tool holder

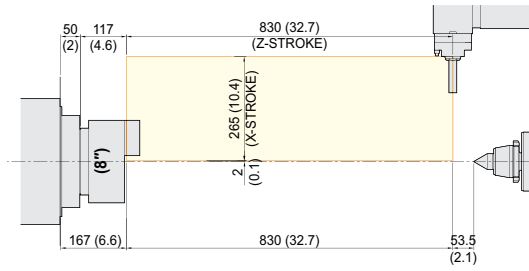

#### Angular driven Tool holder

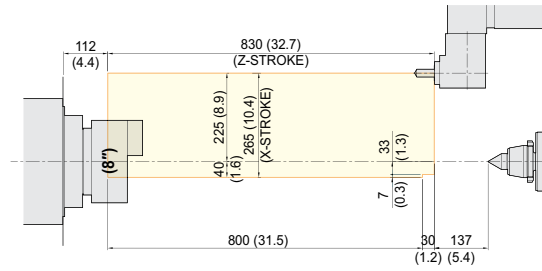

#### Face Tool holder

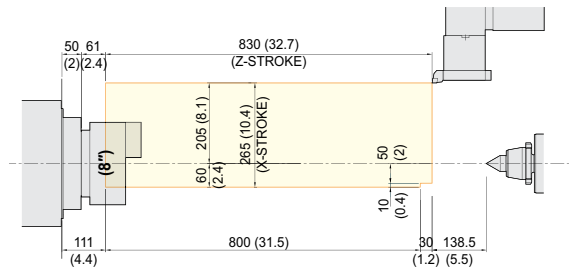

# SPECIFICATIONS

## Tooling Travel Range

unit : mm(in)

### L2000SY

**O.D. Tool holder**

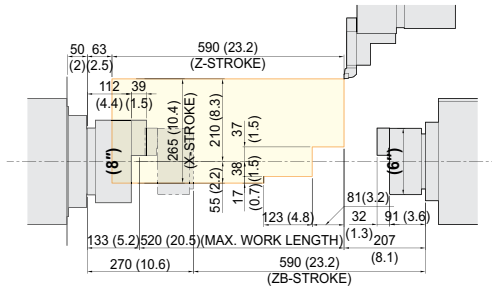

**I.D. Tool holder**

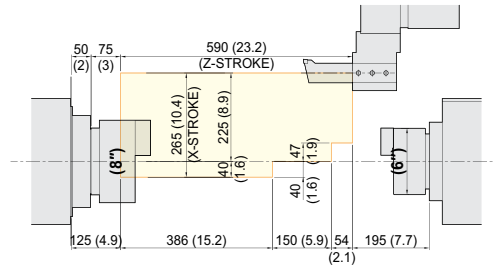

**Double O.D. Tool holder**

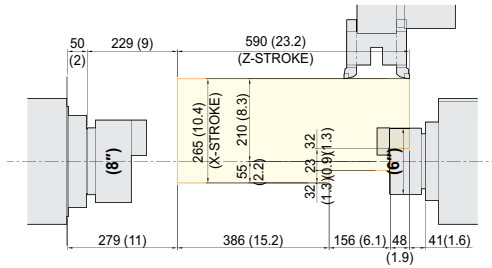

**Double I.D. Tool holder**

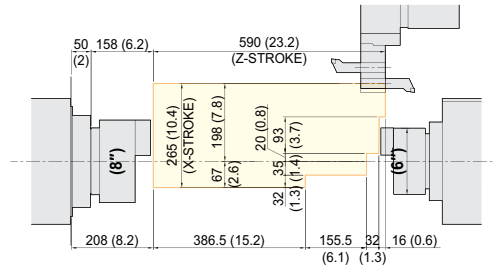

**Axial driven Tool holder**

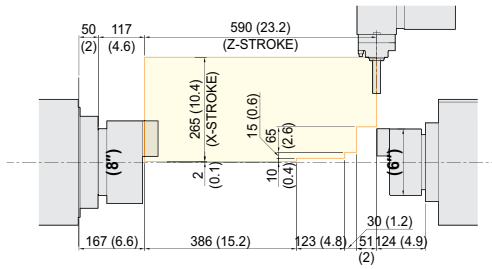

**Angular driven Tool holder**

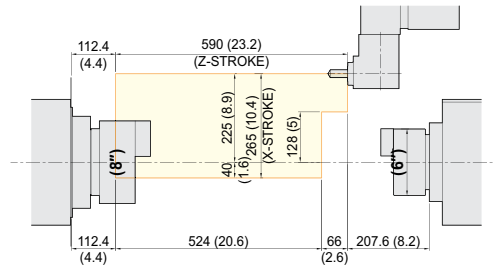

**Face Tool holder**

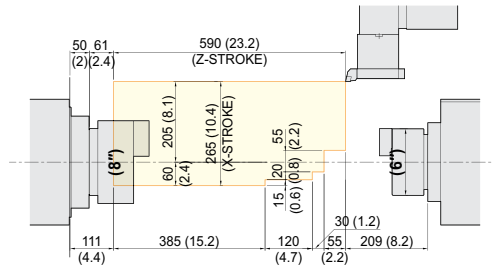

# SPECIFICATIONS

## Tooling Travel Range

unit : mm(in)

### L2000LSY

**O.D. Tool holder**

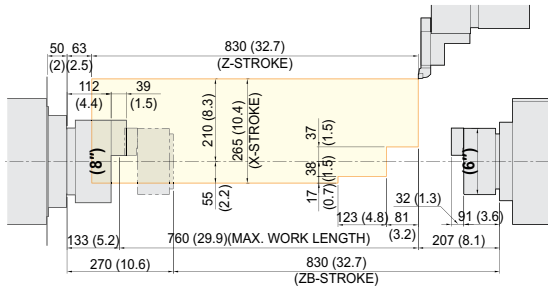

**I.D. Tool holder**

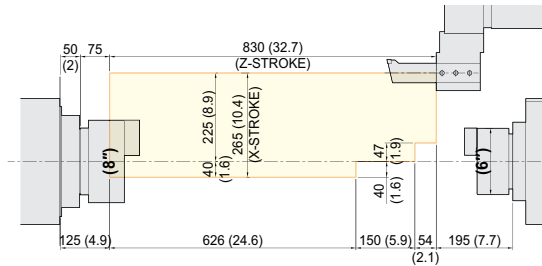

**Double O.D. Tool holder**

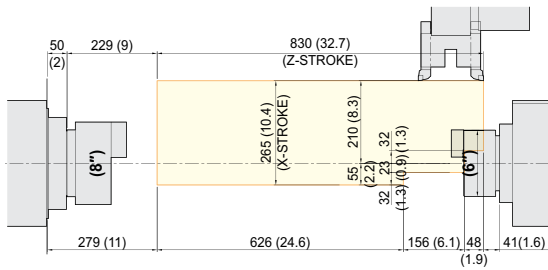

**Double I.D. Tool holder**

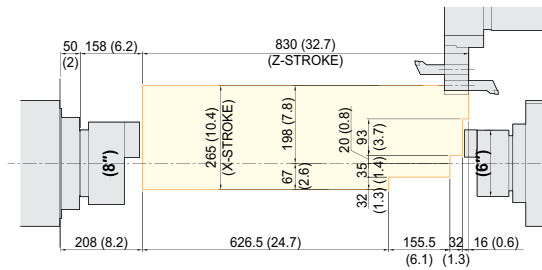

**Axial driven Tool holder**

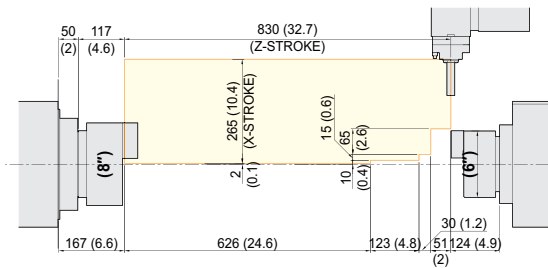

**Angular driven Tool holder**

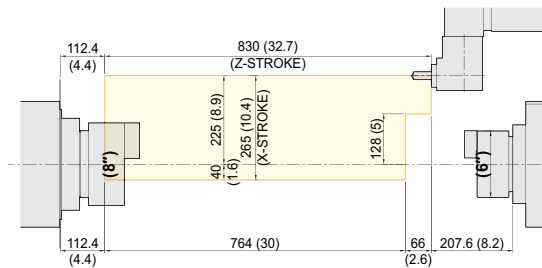

**Face Tool holder**

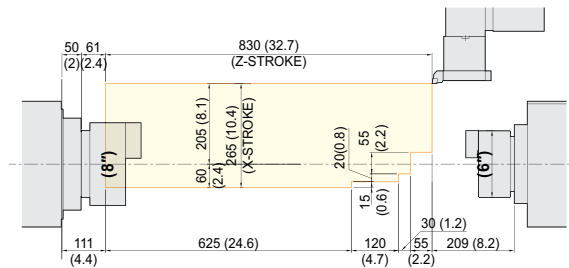

# SPECIFICATIONS

## Tooling Travel Range

unit : mm(in)

L2600Y

**O.D. Tool holder**

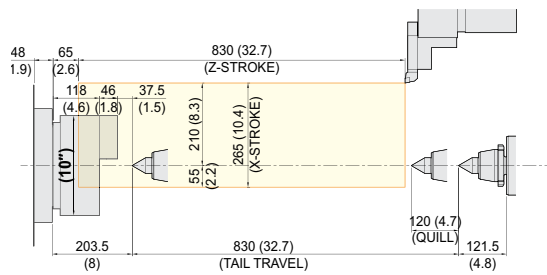

**I.D. Tool holder**

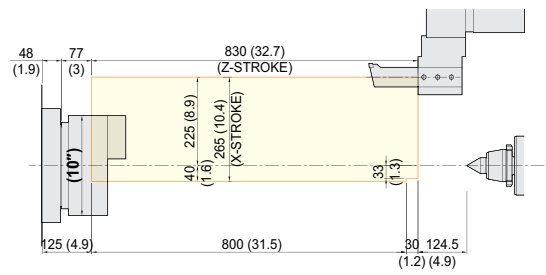

**Axial driven Tool holder**

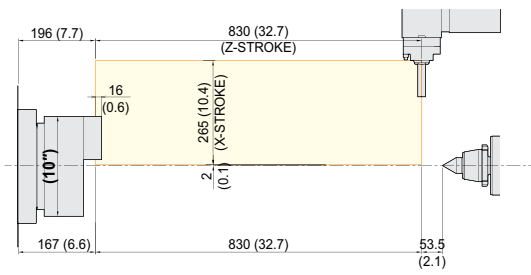

**Angular driven Tool holder**

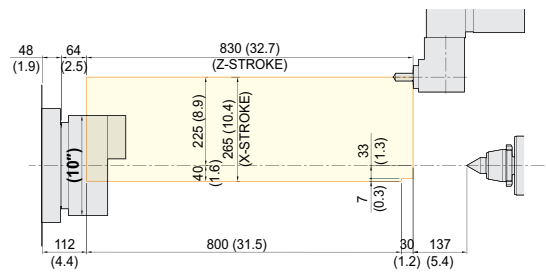

**Face Tool holder**

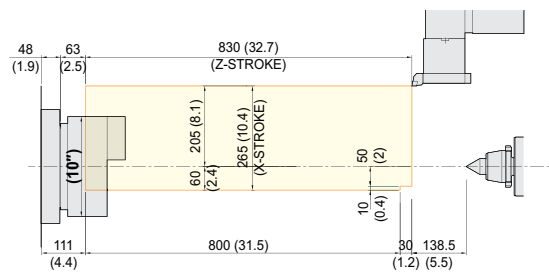

# SPECIFICATIONS

## Tooling Travel Range

unit : mm(in)

### L2600SY

**O.D. Tool holder**

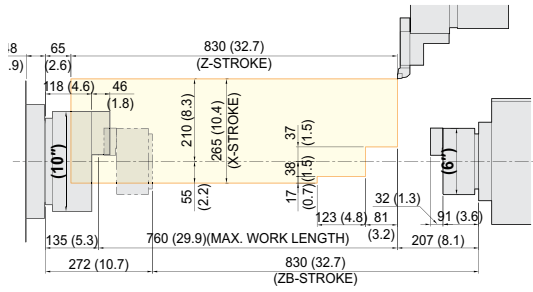

**I.D. Tool holder**

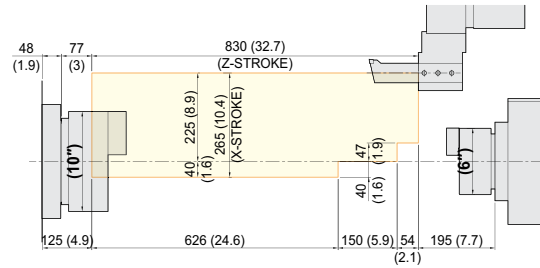

**Double O.D. Tool holder**

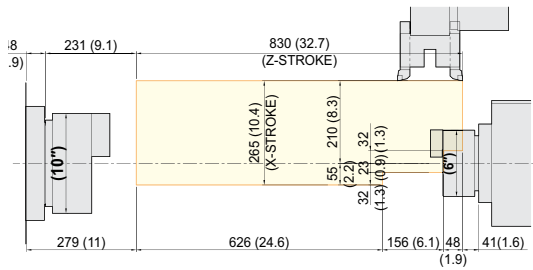

**Double I.D. Tool holder**

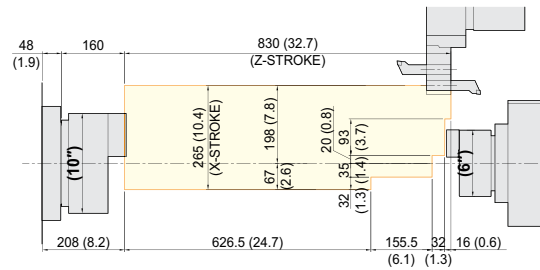

**Axial driven Tool holder**

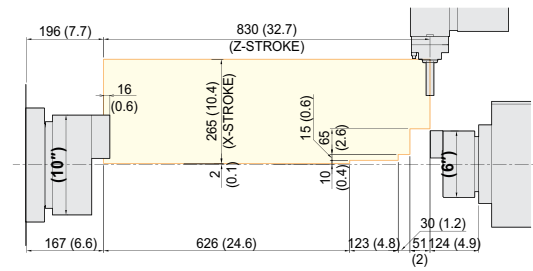

**Angular driven Tool holder**

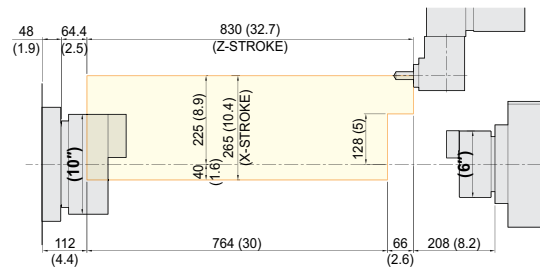

**Face Tool holder**

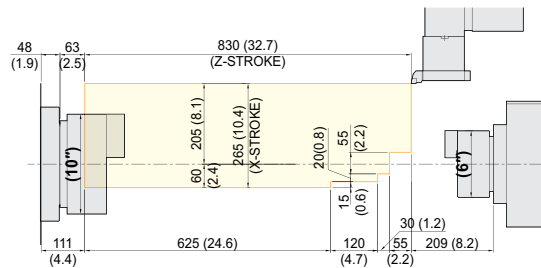



# SPECIFICATIONS

## Tooling Travel Range

unit : mm(in)

L2600LY

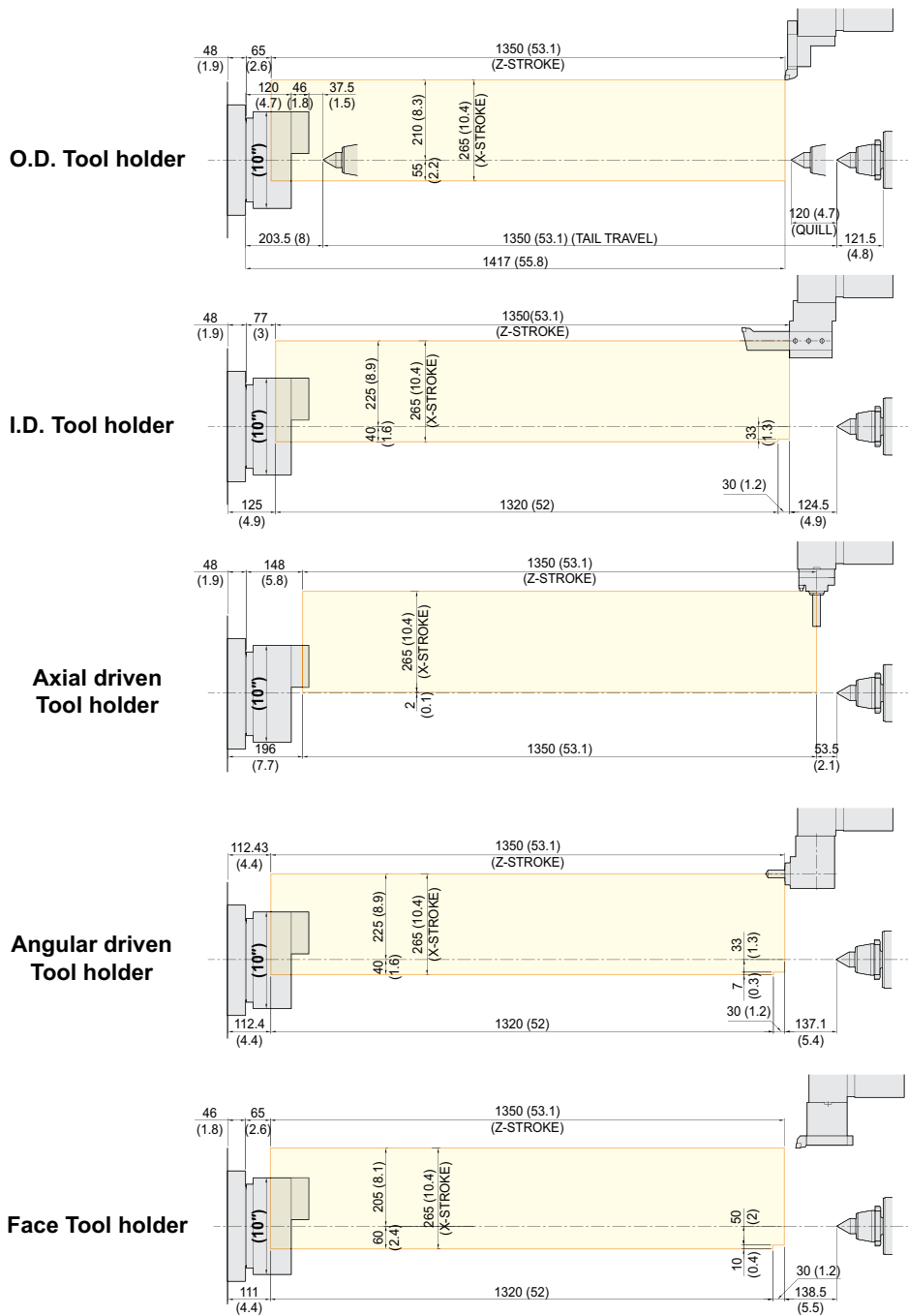

# SPECIFICATIONS

## Tooling Travel Range

unit : mm(in)

### L3000Y

**O.D. Tool holder**

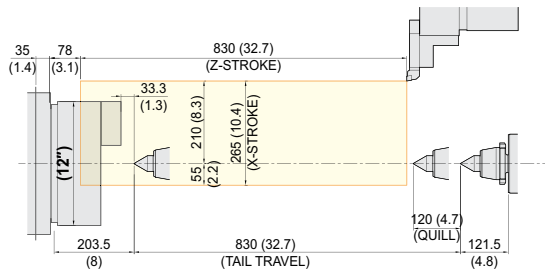

**I.D. Tool holder**

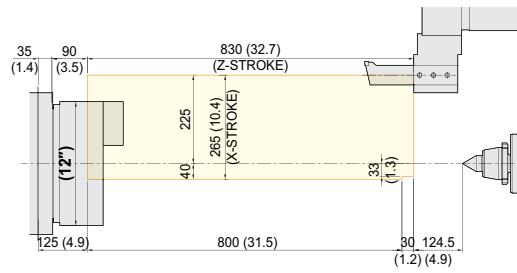

**Axial driven Tool holder**

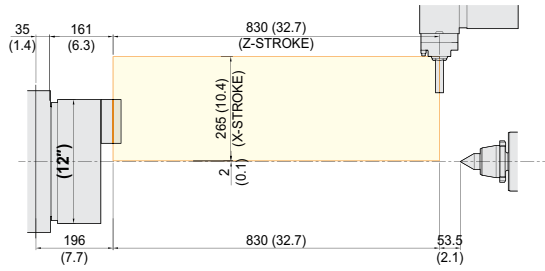

**Angular driven Tool holder**

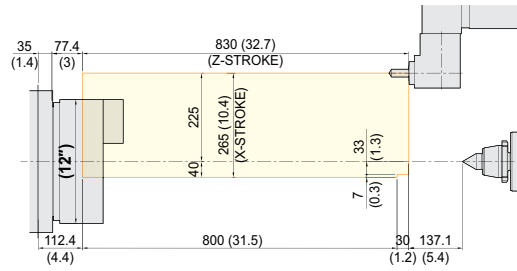

**Face Tool holder**

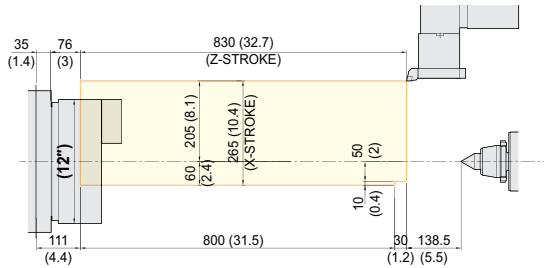

# SPECIFICATIONS

## Tooling Travel Range

unit : mm(in)

### L3000SY

**O.D. Tool holder**

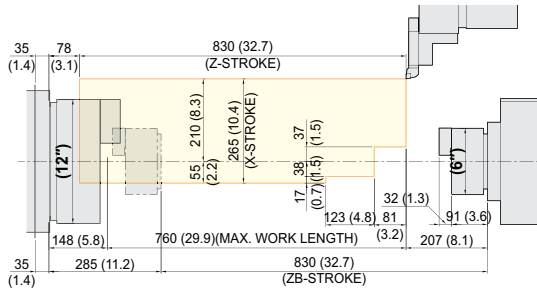

**I.D. Tool holder**

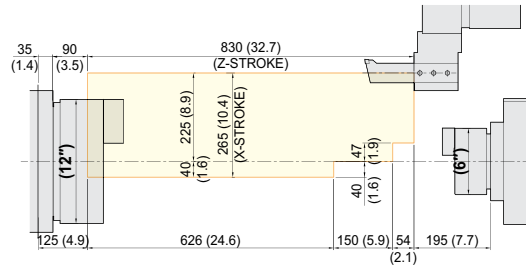

**Double O.D. Tool holder**

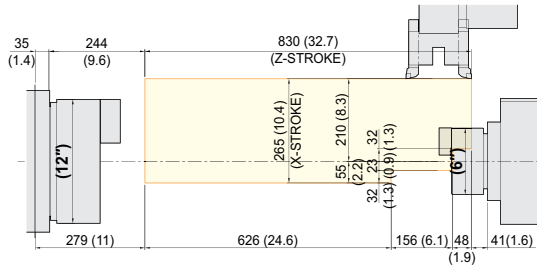

**Double I.D. Tool holder**

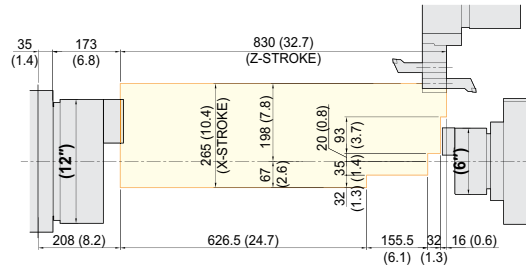

**Axial driven Tool holder**

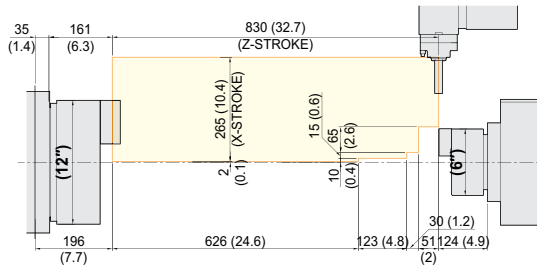

**Angular driven Tool holder**

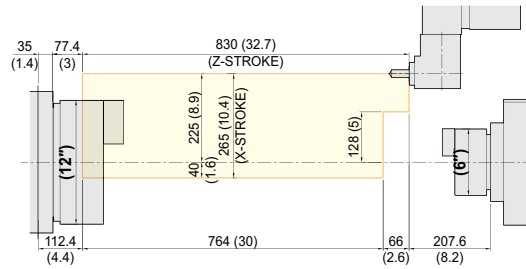

**Face Tool holder**

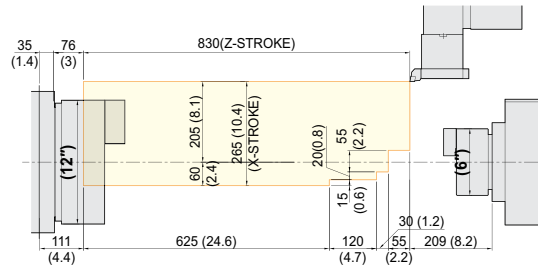

# SPECIFICATIONS

## Tooling Travel Range

unit : mm(in)

### L3000LY

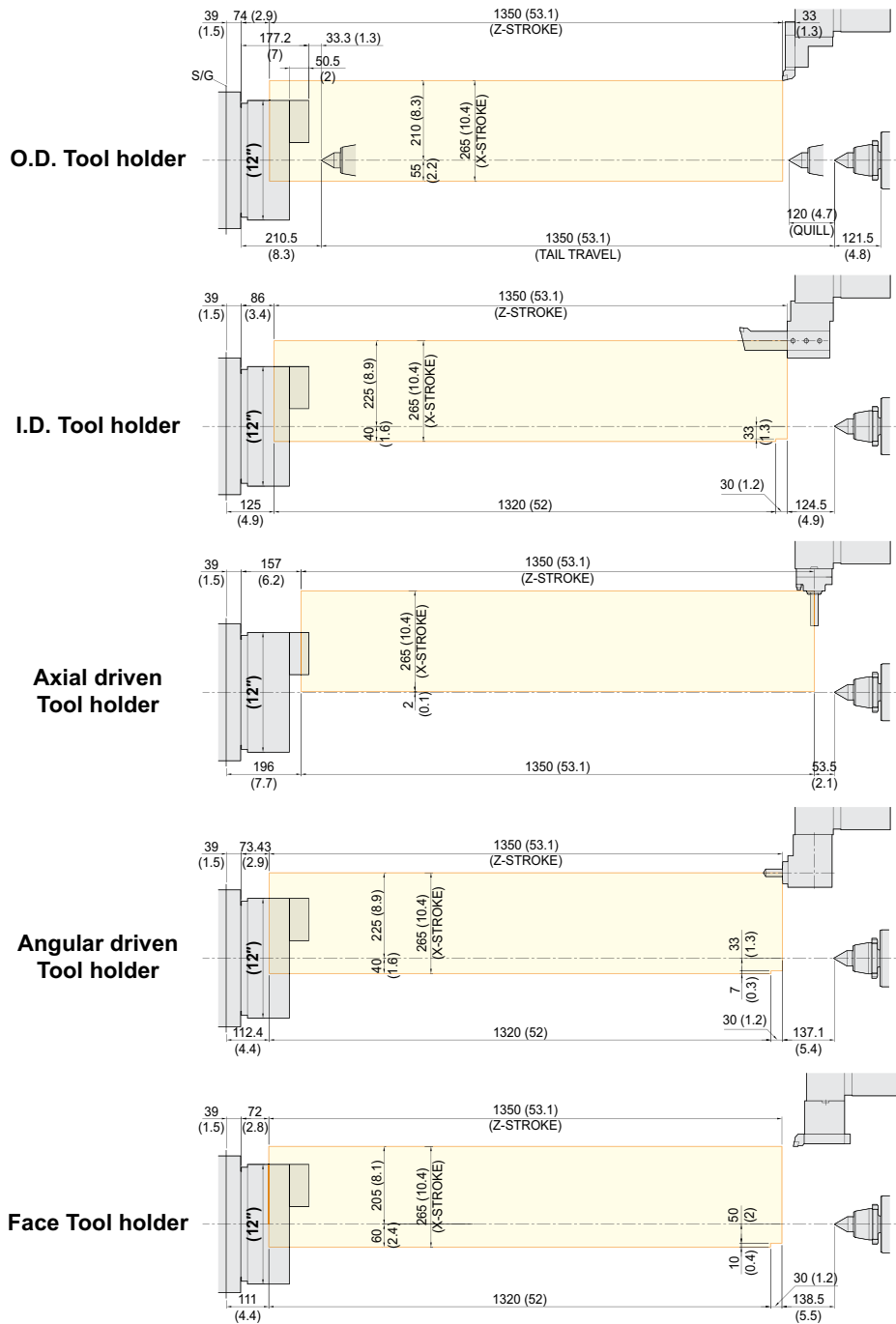

# SPECIFICATIONS

## Specifications

[ ] : Option

ITEM			L2000Y	L2000LY	L2000SY	L2000LSY	
CAPACITY	Swing Over the Bed	mm(in)	Ø800 (31.5")				
	Swing Over the Carriage	mm(in)	Ø670 (26.4")				
	Max. Turning Dia.	mm(in)	Ø420 (16.5")				
	Max. Turning Length	mm(in)	520 (20.5")	760 (29.9")	520 (20.5")	760 (29.9")	
	Bar Capacity	Main	mm(in)	Ø65 (2.6")			
Sub		mm(in)	-		Ø51 (2")		
SPINDLE	Chuck Size	Main	inch	8"			
		Sub	inch	-	6"		
	Spindle Bore	Main	mm(in)	Ø76 (3")			
		Sub	mm(in)	-	Ø62 (2.4")		
	Spindle Speed (rpm)	Main	r/min	5,000 [4,500]			
		Sub	r/min	-	6,000 [4,500]		
	Motor (Max/Cont.)	Main	kw(HP)	22/11 (30/15) [18.5/11 (25/15)]			
		Sub	kw(HP)	-	15/11 (20/15) [11/5.5 (15/7.4)]		
	Torque (Max/Cont.)	Main	N·m(lbf·ft)	358/301 (264/222) [314.2/186.2 (231.7/137.3)]			
		Sub	N·m(lbf·ft)	-	135/99.1 (99.6/73.1) [124/62.1 (91.5/45.8)]		
	Spindle Type	Main	-	BUILT-IN [BELT]			
		Sub	-	-	BUILT-IN [BELT]		
Spindle Nose	Main	-	A2-6				
	Sub	-	-	A2-5			
C-axis Indexing	deg	0.001°					
FEED	Travel	X/Y	mm(in)	265/120 {±60} (10.4"/4.7" {±2.4"})			
		Z/ZB	mm(in)	590 (23.2")	830 (32.7")	590/590 (23.2"/23.2")	830/830 (32.7"/32.7")
	Rapid Traverse Rate	X/Y	m/min(ipm)	30/10 (1,181/394)			
		Z/ZB	m/min(ipm)	30/30 (1,181/1,181)			
Slide Type	-	BOX GUIDE					
TURRET	No. of Tools	ea	12				
	Tool Size	OD	mm(in)	□ 25 (1")			
		ID	mm(in)	Ø50 (2")			
	Indexing Time	sec/step	0.15				
Y-Axis Type	-	WEDGE TYPE					
LIVE TOOL	Motor (Max/Cont.)	kw(HP)	5.5/1.5 (7.4/2) [7.5/1.5 (10/2)]				
	Milling Tool Speed (rpm)	r/min	5,000				
	Torque (Max/Cont.)	N·m(lbf·ft)	47.1/33.7 (34.7/24.9) [95.5/33.7 (70.4/24.9)]				
	Collet Size	mm(in)	Ø25 (1") {ER32}				
	Type	-	BMT65				
TAIL STOCK	Taper	-	MT#5			-	
	Quill Dia.	mm(in)	Ø100 (3.9")				
	Quill Travel	mm(in)	120 (4.7")				
	Travel	mm(in)	590 (23.2")	830 (32.7")			
TANK CAPACITY	Coolant Tank	ℓ (gal)	275 (72.6)	290 (76.6)	275 (72.6)	290 (76.6)	
	Lubricating Tank	ℓ (gal)	3 (0.8)				
POWER SUPPLY	Electric Power Supply	kVA	Built-in : 39 [Belt : 32]		Built-in : 55 [Belt : 38]		
	Thickness of Power Cable	Sq	Over 25		Built-in : Over 50 [Belt : Over 25]		
	Voltage	V/Hz	220/60 (200/50*)				
MACHINE	Floor Space (L×W)	mm(in)	3,220×1,890 (126.8"×74.4")	3,600×1,890 (141.7"×74.4")	3,220×1,890 (126.8"×74.4")	3,600×1,890 (141.7"×74.4")	
	Height	mm(in)	1,950 (76.8)				
	Weight	kg(lb)	5,500 (12,125)	6,000 (13,228)	5,800 (12,787)	6,300 (13,889)	
NC	Controller	-	HYUNDAI WIA FANUC i Series - Smart Plus				

\*) Using 50Hz voltage instead of 60Hz may lower the output of motors. (excluding servo motors and inverter motors)

Specifications are subject to change without notice for improvement.



# CONTROLLER

## Specifications

[ ] : Option

ITEM			L2600Y	L2600LY	L2600SY
CAPACITY	Swing Over the Bed	mm(in)		Ø800 (31.5")	
	Swing Over the Carriage	mm(in)		Ø670 (26.4")	
	Max. Turning Dia.	mm(in)		Ø420 (16.5")	
	Max. Turning Length	mm(in)	760 (29.9")	1,280 (50.4")	760 (29.9")
	Bar Capacity	Main	mm(in)		Ø81 (3.2")
Sub		mm(in)	-		Ø51 (2")
SPINDLE	Chuck Size	Main	inch	10"	
		Sub	inch	-	6" [8"] [6"]
	Spindle Bore	Main	mm(in)	Ø91 (3.6")	
		Sub	mm(in)	-	Ø62 (2.4")
	Spindle Speed (rpm)	Main	r/min	4,000 [3,500]	
		Sub	r/min	-	6,000 [5,000] [4,500]
	Motor (Max/Cont.)	Main	kW(HP)	22/15 (30/20) [26/18.5 (35/25)]	
		Sub	kW(HP)	-	15/11 (20/15) [22/15(30/20)] [11/5.5 (15/7.4)]
	Torque (Max/Cont.)	Main	N·m(lbf·ft)	599/409 (441.8/301.7) [733.7/522.1 (541.1/385.1)]	
		Sub	N·m(lbf·ft)	-	135/99.1 (99.6/73.1) [221/159 (163/117.3)] [124/62.1 (91.5/45.8)]
	Spindle Type	Main	-	Built-in [Belt]	
		Sub	-	-	Built-in [Built-in] [Belt]
Spindle Nose	Main	-	A2-8		
	Sub	-	-	A2-5	
C-axis Indexing	deg	0.001°			
FEED	Travel	X/Y	mm(in)		265/120 {±60} (10.4"/4.7" {±2.4"})
		Z/ZB	mm(in)	830 (32.7")	1,350 (53.1) 830/830 (32.7"/32.7")
	Rapid Traverse Rate	X/Y	m/min(ipm)	30/10 (1,181/394)	
		Z/ZB	m/min(ipm)	30/30 (1,181/1,181)	
Slide Type	-	BOX GUIDE			
TURRET	No. of Tools	ea	12		
	Tool Size	OD	mm(in)	□ 25 (1")	
		ID	mm(in)	Ø50 (2")	
	Indexing Time	sec/step	0.15		
Y-Axis Type	-	WEDGE TYPE			
LIVE TOOL	Motor (Max/Cont.)	kW(HP)	5.5/1.5 (7.4/2) [7.5/1.5 (10/2)]		
	Milling Tool Speed (rpm)	r/min	5,000		
	Torque (Max/Cont.)	N·m(lbf·ft)	47.1/33.7 (34.7/24.9) [95.5/33.7 (70.4/24.9)]		
	Collet Size	mm(in)	Ø25 (1") {ER32}		
	Type	-	BMT65		
TAIL STOCK	Taper	-	MT#5		
	Quill Dia.	mm(in)	Ø100 (3.9")		
	Quill Travel	mm(in)	120 (4.7")		
	Travel	mm(in)	830 (32.7")	1,350 (53.1)	-
TANK CAPACITY	Coolant Tank	ℓ (gal)	290 (76.6)	320 (84.5)	290 (76.6)
	Lubricating Tank	ℓ (gal)	3 (0.8)		
POWER SUPPLY	Electric Power Supply	kVA	Built-in : 39 [Belt : 37]		Built-in : 55 [Belt : 46]
	Thickness of Power Cable	Sq	Over 25		Built-in : Over 50 [Belt : Over 35]
	Voltage	V/Hz	220/60 (200/50*)		
MACHINE	Floor Space (L×W)	mm(in)	3,600×1,890 (141.7"×74.4")	4,120×1,890 (162.2"×74.4")	3,600×1,890 (141.7"×74.4")
	Height	mm(in)	1,950 (76.8)		
	Weight	kg(lb)	6,200 (13,669)	7,500 (16,535)	6,550 (14,440)
PC	Controller	-	HYUNDAI WIA FANUC i Series - Smart Plus		

\*) Using 50Hz voltage instead of 60Hz may lower the output of motors. (excluding servo motors and inverter motors)  
Specifications are subject to change without notice for improvement.

# SPECIFICATIONS

## Specifications

[ ] : Option

ITEM			L3000Y	L3000LY	L3000SY
CAPACITY	Swing Over the Bed	mm(in)	Ø800 (31.5")		
	Swing Over the Carriage	mm(in)	Ø670 (26.4")		
	Max. Turning Dia.	mm(in)	Ø420 (16.5")		
	Max. Turning Length	mm(in)	760 (29.9")	1,280 (50.4")	760 (29.9")
	Bar Capacity	Main	mm(in)	Ø102 (4")	
Sub		mm(in)	-		
SPINDLE	Chuck Size	Main	12"		
		Sub	-		
	Spindle Bore	Main	Ø115 (4.5")		
		Sub	-		
	Spindle Speed (rpm)	Main	3,000 [2,800]		
		Sub	-		
	Motor (Max/Cont.)	Main	37/25 (50/33.5) [26/18.5 (35/25)]		
		Sub	-		
	Torque (Max/Cont.)	Main	1,262/1,003 (930.8/739.8) [1,123/664 (828.2/489.7)]		
		Sub	-		
	Spindle Type	Main	Built-in [Belt]		
		Sub	-		
	Spindle Nose	Main	A2-11		
Sub		-			
C-axis Indexing	deg	0.001°			
FEED	Travel	X/Y	265/120 {±60} (10.4"/4.7" {±2.4"})		
		Z/ZB	830 (32.7")	1,350 (53.1)	830/830 (32.7"/32.7")
	Rapid Traverse Rate	X/Y	30/10 (1,181/394)		
		Z/ZB	30/30 (1,181/1,181)		
Slide Type	-	BOX GUIDE			
TURRET	No. of Tools	ea	12		
	Tool Size	OD	□ 25 (1")		
		ID	Ø50 (2")		
	Indexing Time	sec/step	0.15		
Y-Axis Type	-	WEDGE TYPE			
LIVE TOOL	Motor (Max/Cont.)	kw(HP)	5.5/1.5 (7.4/2) [7.5/1.5 (10/2)]		
	Milling Tool Speed (rpm)	r/min	5,000		
	Torque (Max/Cont.)	N·m(lbf·ft)	47.1/33.7 (34.7/24.9) [95.5/33.7 (70.4/24.9)]		
	Collet Size	mm(in)	Ø25 (1") {ER32}		
	Type	-	BMT65		
TAIL STOCK	Taper	-	MT#5		
	Quill Dia.	mm(in)	Ø100 (3.9")		
	Quill Travel	mm(in)	120 (4.7")		
	Travel	mm(in)	830 (32.7")	1,350 (53.1)	-
TANK CAPACITY	Coolant Tank	ℓ (gal)	290 (76.6)	320 (84.5)	290 (76.6)
	Lubricating Tank	ℓ (gal)	3 (0.8)		
POWER SUPPLY	Electric Power Supply	kVA	Built-in : 52 [Belt : 37]		Built-in : 68 [Belt : 46]
	Thickness of Power Cable	Sq	Over 35		Built-in : Over 70 [Belt : Over 35]
	Voltage	V/Hz	220/60 (200/50*)		
MACHINE	Floor Space (L×W)	mm(in)	3,600×1,890 (141.7"×74.4")	4,320×1,890 (170.1"×74.4")	3,600×1,890 (141.7"×74.4")
	Height	mm(in)	1,950 (76.8")		
	Weight	kg(lb)	6,700 (14,771)	7,800 (17,196)	6,900 (15,212)
NC	Controller	-	HYUNDAI WIA FANUC i Series - Smart Plus		

\*) Using 50Hz voltage instead of 60Hz may lower the output of motors. (excluding servo motors and inverter motors)  
Specifications are subject to change without notice for improvement.

# CONTROLLER

## HYUNDAI WIA FANUC i Series – Smart Plus

[ ] : Option

Controlled axis / Display / Accuracy Compensation	
Control axes	2 axes (X, Z) / 3 axes (X, Z, C) / 4 axes (X,Z,Y,C) 5 axes (X, Z, B, C, A) / 6 axes (X, Z, Y, B, C, A) 7 axes (X1/Z1, X2/Z2, B2, C1/C2)
Simultaneously controlled axes	2 axes [Max. 4 axes]
Designation of spindle axes	3 axes [Max. 4 axes]
Least setting Unit	X, Z, Y, B axes : 0.001 mm (0.0001 inch) C, A axes : 0.001 deg
Least input increment	X, Z, Y, B axes : 0.001 mm (0.0001 inch) C, A axes : 0.001 deg
Inch / Metric conversion	G20 / G21
High response vector control	
Interlock	All axes / Each axis
Machine lock	All axes
Backlash compensation	± 0~9999 pulses (exc. Rapid traverse / Cutting feed)
Position switch	
LCD / MDI	15 inch LCD unit (with Touch Panel)
Feedback	Absolute motor feedback
Stored stroke check 1	Over travel
Stored stroke check 2, 3	
PMC axis control	
Operation	
Automatic operation (Memory)	
MDI operation	
DNC operation	Needed DNC software / CF card
Program restart	
Wrong operation prevention	
Program check function	Dry run
Single block	
Search function	Program Number / Sequence Number
Interpolation functions	
Nano interpolation	
Positioning	G00
Linear interpolation	G01
Circular interpolation	G02, G03
Exact stop mode	Single : G09, Continuous : G61
Dwell	G04, 0 ~ 9999.9999 sec
Skip	G31
Reference position return	1st reference : G28, 2nd reference : G30 Ref. position check : G27
Thread synchronous cutting	G33
Thread cutting retract	
Variable lead thread cutting	
Multi / Continuous threading	
Feed function / Acc. & Dec. control	
Manual feed	Rapid traverse Jog : 0~2,000 mm/min (79 ipm) Manual handle : x1, x10, x100 pulses Reference position return
Cutting Feed command	Direct input F code
Feedrate override	0 ~ 200% (10% Unit)
Rapid traverse override	1%, F25%, 50%, 100%
Override cancel	
Feed per minute	G98
Feed per revolution	G99
Look-ahead block	1 block
Program input	
Tape Code	EIA / ISO
Optional block skip	9 ea
Program stop / end	M00, M01 / M02, M30
Maximum command unit	± 999,999.999 mm (± 99,999.9999 inch)
Plane selection	X-Y : G17 / Z-X : G18 / Y-Z : G19
Workpiece coordinate system	G52, G53, 6 pairs (G54 ~ G59)
Manual absolute	Fixed ON
Programmable data input	G10
Sub program call	10 folds nested
Custom macro	#100 ~ #199, #500 ~ #999
G code system	A, B/C
Programmable mirror image	G51.1, G50.1
G code preventing buffering	G4.1
Direct drawing dimension program	Including Chamfering / Corner R
Conversational Program	SmartGuide-i

Program input	
Multiple repetitive cycles	I, II
Canned cycle for turning	
Auxiliary function / Spindle speed function	
Auxiliary function	M & 4 digit
Level-up M Code	High speed / Multi / Bypass M code
Spindle speed function	S & 5 digit, Binary output
Spindle override	0% ~ 150% (10% Unit)
Multi position spindle orientation	M19 (S##)
Rigid tapping	
Constant surface speed control	G96, G97
Tool function / Tool compensation	
Tool function	T & 2 digit + Offset 2 digit
Tool life management	
Tool offset pairs	128 pairs
Tool nose radius compensation	G40, G41, G42
Geometry / Wear compensation	
Direct input of offset measured B	
Editing function	
Part program storage size	5,120m (2MB)
No. of registerable programs	1,000 ea
Program protect	
Background editing	
Extended part program editing	Copy, move and change of NC program
Memory card program edit	
Data input / output & Interface	
I/O interface	CF card, USB memory Embedded Ethernet interface
Screen hard copy	
External message	
External key input	
External workpiece number search	
Automatic data backup	
Setting, display and diagnosis	
Self-diagnosis function	
History display & Operation	Alarm & Operator message & Operation
Run hour / Parts count display	
Maintenance information	
Actual cutting feedrate display	
Display of spindle speed / T code	
Graphic display	
Operating monitor screen	Spindle / Servo load etc.
Power consumption monitoring	Spindle & Servo
Spindle / Servo setting screen	
Multi language display	Support 24 languages
Display language switching	Selection of 5 optional Languages
LCD Screen Saver	Screen saver
Unexpected disturbance torque	BST (Back spin torque limit)
Function for machine type	
Cs contour control (C & A axes)	Mill, MS, Y, SY, LF-Mill, TTMS, TTSY
Polar coordinate interpolation	Mill, MS, Y, SY, LF-Mill, TTMS, TTSY
Cylindrical interpolation	Mill, MS, Y, SY, LF-Mill, TTMS, TTSY
Polygon turning (2 Spindles)	Mill, MS, Y, SY, LF-Mill, TTMS, TTSY
Canned cycle for drilling	Mill, MS, Y, SY, LF-Mill, TTMS, TTSY
Spindle orientation expansion	MS, SY, TTS, TTMS, TTSY
Spindle synchronous control	MS, SY, TTS, TTMS, TTSY
Torque control	MS, SY, TTS, TTMS, TTSY
Y axis offset	Y, SY, TTSY
Arbitrary angular control	Y, SY, TTSY
Composite / Superimposed control	MS, SY, TTS, TTMS, TTSY
Balance cutting	TTS, TTMS, TTSY
Option	
Fast ethernet	Needed option board
Data server	Needed option board
Protection of data at 8 levels	
Tool offset pairs	200 pairs
Helical interpolation	
Optional block skip	40 ea, 200 ea (AICC II)

Figures in inch are converted from metric values.

The FANUC controller specifications are subject to change based on the policy of company CNC supplying.



L2600SY  
Movie



L2600SY  
3D Movie



**You Tube** HYUNDAI WIA MT

[www.youtube.com/HYUNDAIWIAMT](http://www.youtube.com/HYUNDAIWIAMT)

## EXPERIENCE THE NEW TECHNOLOGY

With its top-quality HYUNDAI WIA machine tool creates a new and better world.



<http://machine.hyundai-wia.com>

HYUNDAI WIA Machine Tools  
Global Links

### HEADQUARTER

**Changwon Technical Center/R&D Center/Factory** 153, Jeongdong-ro, Seongsan-gu, Changwon-si, Gyeongsangnam-do, Korea TEL : +82 55 280 9114 FAX : +82 55 282 9114

**Overseas Sales Team /R&D Center** 37, Cheoldobangmulgwan-ro, Uiwang-si, Gyeonggi-do, Korea TEL : +82 31 8090 2539

### OVERSEAS OFFICES

**HYUNDAI WIA Machine America corp.** 450 Commerce Blvd, Carlstadt, NJ 07072, USA TEL : +1-201-987-7298

**HYUNDAI WIA Europe GmbH** Alexander-Fleming-Ring 57, 65428 Rüsselsheim Germany TEL : +49-0-6142-9256-0

**HYUNDAI WIA Machine Tools China** 2-3F, Bldg6, No.1535 Hongmei Road, Xuhui District, Shanghai, China TEL : +86-21-6427-9885

**India Branch Office** #4/169, 1st Floor, LOTTE BLDG, Rajiv Gandhi Salai, (OMR), Kandanchavadi, Chennai - 600096, Tamilnadu, India TEL : +91-76-0490-3348

**Vietnam Branch Office** Flat number 05, Service and Trade Center of Viet Huong Industrial Zone, Highway 13, Thuan Giao, Thuan An, Binh Duong, Vietnam TEL : +84-3-5399-5099